



## User Guide

SC1-ALLEGRO • *CompactPCI*<sup>®</sup> Serial CPU Card  
Intel<sup>®</sup> Core™ i7-3xxx Processor Quad-Core (Ivy Bridge)

Document No. 6782 • Edition 30 • 4 October 2018



## Contents

About this Manual	4
Edition History	4
Related Documents	5
Nomenclature	5
Trade Marks	5
Legal Disclaimer - Liability Exclusion	5
Standards	6
Overview	7
Technical Features	9
Feature Summary	9
Operating Conditions	10
Power Requirements	10
Block Diagram	11
Top View Component Assembly	12
Front Panel Connectors	13
Front Panel Switches & Indicators	13
On-Board Connectors & Sockets	14
Pin Headers	14
Jumpers	14
Microprocessor	15
Thermal Considerations	16
Main Memory	18
Graphics Subsystem	19
LAN Subsystem	19
Serial ATA Interface (SATA)	20
PCI Express® Interface	20
Universal Serial Bus (USB)	21
Utility Interfaces	21
Real-Time Clock	22
SPI Flash	22
Reset	23
Watchdog	25
Front Panel LEDs	25
PG (Power Good) LED	26
GP (General Purpose) LED	26
HD (Hard Disk Activity) LED	26
EB (Ethernet Backplane) LED	27
Main Power Supply Control (PS_ON#)	27
Power Supply Status (PWR_FAIL#)	27
Mezzanine Side Board Options	28
<i>CompactPC</i> <sup>®</sup> Serial	35
System Slot Controller	35
Peripheral Slot Operation	39
Board Hot-Plug	39
Installing and Replacing Components	42
Before You Begin	42
Installing the Board	43
Removing the Board	44
EMC Recommendations	45

Replacement of the Battery	46
Technical Reference	47
Local PCI Devices	47
Local SMB Devices	48
Hardware Monitor LM87	48
Board Control and Status Registers	49
Write/Read Control Register 0	49
Read/Clear Status Register 0	50
Read/Clear Status Register 1	51
Read PLD Revision Register	51
GPIO Usage	52
GPIO Usage QM77 PCH	52
Configuration Jumpers	54
Configuration PCI Express Switch (DS-P)	54
Loading UEFI BIOS Setup Defaults (P-GP)	55
Manufacturer Mode Jumper (P-MFG)	55
RTC Reset (P-RTC)	56
Connectors	57
Front Panel Connectors	57
DisplayPort Connectors	58
VGA Video Connector	61
USB Connectors	62
Ethernet Connectors	63
Mezzanine Connectors	64
Expansion Interface J-EXP	65
High Speed Expansion Connector J-HSE	66
PCI Express <sup>®</sup> Expansion Header J-PCIE	67
SDVO/DisplayPort Expansion Header J-SDVO	68
Pin Headers & Debug	71
Front Panel Handle Microswitch Header P-FPH	71
PLD Programming Header P-ISP	71
Processor Debug Header XDP1	72
Backplane Connectors	73
<i>CompactPCI</i> <sup>®</sup> Serial Backplane Connector P1	74
<i>CompactPCI</i> <sup>®</sup> Serial Backplane Connector P2	75
<i>CompactPCI</i> <sup>®</sup> Serial Backplane Connector P3	76
<i>CompactPCI</i> <sup>®</sup> Serial Backplane Connector P4	77
<i>CompactPCI</i> <sup>®</sup> Serial Backplane Connector P5	78
<i>CompactPCI</i> <sup>®</sup> Serial Backplane Connector P6	79
Appendix	80
Mechanical Drawing	80

## About this Manual

This manual describes the technical aspects of the SC1-ALLEGRO, required for installation and system integration. It is intended for the experienced user only.

## Edition History

Ed.	Contents/ <i>Changes</i>	Author	Date
1	User Manual SC1-ALLEGRO, english, preliminary edition Text #6782, File: sc1_ug.wpd	gn	2012-07-16
2	Added photos	jj	11 September 2012
3	Changed name of DS_P to DS-P, removed the "not connected" note of 2 <sup>nd</sup> USB3 port on CompactPCI Serial connector P3, Memory Down and SO-DIMM are changed to PC3-12800.	gn	2012-11-09
4	Added changes to PCH GPIO assignment coming with rev. 1	gn	2012-12-21
5	Added illustration backplane resources	jj	14 February 2013
6	Changes to section "Serial ATA Interfaces"	gn	2013-02-15
7	Added recommendation regarding DisplayPort cable (pin 20 issue)	jj	5 March 2013
8	Added photos, e.g. SC1 with PCS-BALLET Side Card, and BlueLine Small Systems Rack	jj	30 April 2013
9	Removed display of JMB393 failures via red part of HD LED; Added changes to CompactPCI Serial and J-HSE SATA assignments coming with rev. 2	gn	2013-05-07
10	Added Power Requirements	gn	2013-06-03
11	Added MTBF	gn	2013-06-04
12	Corrected tables concerning DS-P switch in section "Configuration PCI Express Switch (DS-P)"	gn	2013-09-26
13	Reworked section "Watchdog"	gn	2013-12-06
14	Added Section "Board Control and Status Registers" Removed typo in table "P2 CompactPCI Serial Connector"	gn	2014-08-07
15	Added Power Requirements of SC1-041X	gn	2014-09-29
16	Additions to section "CompactPCI Serial"	gn	2014-11-19
17	Clarified resetting of UEFI BIOS settings to factory defaults	gn	2015-01-16
18	Added comment to PCIe polarity inversion on table "P2 CompactPCI Serial Connector"	gn	2015-01-26
19	Updated description of BCSR Control Register 0	gn	2015-02-26
20	Added illustration 'backplane resources' w. system slot right aligned, added photos SC1 with SCS-TRUMPET side card	jj	26 February 2015
21	Updated description of BCSR Status Registers 0 and 1	gn	2015-04-01
22	Cleaned up section "Watchdog"	gn	2015-04-07
23	Updated LM87 Information	mib	2015-05-28
24	Added photos SC1-ALLEGRO with C48-M2 mezzanine module	jj	28 May 2015

Ed.	Contents/Changes	Author	Date
25	Table 'Feature Summary' - added RTOS support	jj	1 October 2015
26	Table 'Feature Summary' - added performance rating	jj	30 October 2015
27	Marked backplane connector P1 pin G3 (SATA_SDI) as "not connected"	gn	2016-08-05
28	Added Celeron® 1047UE processor to table 'Feature Summary'	jj	31 March 2017
29	Celeron® 1047UE as SKU processor in table 'Feature Summary'	jj	6 April 2017
30	Mixup fixed - MTBF valid for 40°C (not 50°C)	jj	4 October 2018

## Related Documents

Related Information SC1-ALLEGRO	
SC1-ALLEGRO Home	<a href="http://www.ekf.com/s/sc1/sc1.html">www.ekf.com/s/sc1/sc1.html</a>
SC1-ALLEGRO Product Information	<a href="http://www.ekf.com/s/sc1/sc1_pi.pdf">www.ekf.com/s/sc1/sc1_pi.pdf</a>

## Nomenclature

Signal names used herein with an attached '#' designate active low lines.

## Trade Marks

Some terms used herein are property of their respective owners, e.g.

- ▶ Chief River, Ivy Bridge, Panther Point, Core i7: ® Intel
- ▶ CompactPCI, CompactPCI PlusIO, CompactPCI Serial: ® PICMG
- ▶ Windows XP, Windows 7: ® Microsoft
- ▶ EKF, ekf system: ® EKF

EKF does not claim this list to be complete.

## Legal Disclaimer - Liability Exclusion

This manual has been edited as carefully as possible. We apologize for any potential mistake. Information provided herein is designated exclusively to the proficient user (system integrator, engineer). EKF can accept no responsibility for any damage caused by the use of this manual.

Please note: If an EKF product has been labelled with contact [support@ekf.com](mailto:support@ekf.com) for availability of additional usage.



this special sign according to ISO 7010 M002, please documentation which may be important for proper

## Standards

Reference Documents		
Term	Document	Origin
CFast™	CFast™ Specification Rev. 1.0	<a href="http://www.compactflash.org">www.compactflash.org</a>
<i>CompactPCI®</i>	CompactPCI Specification, PICMG® 2.0 R3.0, Oct. 1, 1999	<a href="http://www.picmg.org">www.picmg.org</a>
<i>CompactPCI®</i> PlusIO	CompactPCI PlusIO Specification, PICMG® 2.30 R1.0, November 11, 2009	<a href="http://www.picmg.org">www.picmg.org</a>
<i>CompactPCI®</i> Serial	CompactPCI Serial Specification, PICMG® CPCI-S.0 R1.0, March 2, 2011	<a href="http://www.picmg.org">www.picmg.org</a>
DisplayPort	VESA DisplayPort Standard Version 1.1a January 11, 2008 VESA Mini DisplayPort Connector Standard Version 1 October 26, 2009	<a href="http://www.vesa.org">www.vesa.org</a>
DVI	Digital Visual Interface Rev. 1.0 Digital Display Working Group	<a href="http://www.ddwg.org">www.ddwg.org</a>
Ethernet	IEEE Std 802.3, 2000 Edition	<a href="http://standards.ieee.org">standards.ieee.org</a>
LPC	Low Pin Count Interface Specification, Revision 1.1	<a href="http://developer.intel.com/design/chipsets/industry/lpc.htm">developer.intel.com/design/ chipsets/industry/lpc.htm</a>
HD Audio	High Definition Audio Specification Rev.1.0	<a href="http://www.intel.com/design/chipsets/hdaudio.htm">www.intel.com/design/chipsets/ hdaudio.htm</a>
PCI Express®	PCI Express® Base Specification 3.0	<a href="http://www.pcisig.com">www.pcisig.com</a>
SATA	Serial ATA 2.5/2.6 Specification Serial ATA 3.0 & 3.1 Specification	<a href="http://www.sata-io.org">www.sata-io.org</a>
USB	Universal Serial Bus 3.0 Specification, Revision 1.0 November 12, 2008	<a href="http://www.usb.org">www.usb.org</a>

## Overview

*The SC1-ALLEGRO is a rich featured high performance 4HP/3U CompactPCI<sup>®</sup> Serial CPU board, equipped with an Intel® Core™ i7 Mobile 3<sup>rd</sup> Generation + ECC (dual- or quad-core) processor based on 22nm technology. The SC1-ALLEGRO front panel is provided with two Gigabit Ethernet jacks, two USB 3.0 receptacles, and two Mini-DisplayPort connectors for attachment of high resolution digital displays, configured e.g. as extended desktop.*

While mechanically compliant to *CompactPCI*<sup>®</sup> Classic, *CompactPCI*<sup>®</sup> Serial (PICMG<sup>®</sup> CPCIS.0) defines a completely new card slot, based on PCI Express<sup>®</sup>, SATA, Gigabit Ethernet and USB serial data lines. Up to 6 high-speed backplane connectors P1 - P6 are provided on a system slot controller such as the SC1-ALLEGRO, which can be considered as a root hub with respect to most signal lines. A passive backplane is used for distribution of a defined subset of I/O channels from the system slot to each of up to eight peripheral slots in a *CompactPCI*<sup>®</sup> Serial system.

The SC1-ALLEGRO is equipped with a set of local expansion interface connectors, which can be optionally used to attach a mezzanine side board. A variety of expansion cards is available, e.g. providing legacy I/O and additional PCI Express<sup>®</sup> based I/O controllers such as SATA, USB 3.0 and Gigabit Ethernet, or a third video output. Most mezzanine side cards can accommodate in addition a 2.5-inch drive.

The SC1-ALLEGRO is equipped with up to 16GB RAM with ECC support. 8GB memory-down are provided for rugged applications, and another 8GB are available via the DDR3 ECC SO-DIMM socket. As an option, a low profile mezzanine module with dual mSATA SSDs may serve as a high-speed RAID mass storage solution. The SC1-ALLEGRO backplane connectors comply with the PICMG<sup>®</sup> *CompactPCI*<sup>®</sup> Serial system slot specification.

Most *CompactPCI*<sup>®</sup> Serial peripheral slot cards require only the backplane connector P1, which comprises PCIe, SATA and USB signals, resulting in a concise and inexpensive peripheral board design. More powerful peripheral cards profit from so called Fat Pipe slots (PCIe x 8).

The SC1-ALLEGRO is a native *CompactPCI*<sup>®</sup> Serial CPU card, suitable for usage in a pure CPCI Serial environment. Due to its generous backplane capabilities (20 x PCI Express<sup>®</sup> lanes, 6 x USB, 7 x SATA/RAID, 2 x GbE), very powerful industrial systems can be built.

Typically, the SC1-ALLEGRO and the related side card would come as a readily assembled 8HP unit. As an alternate, low profile Flash based mezzanine storage modules are available that fit on the SC1-ALLEGRO while maintaining the 4HP profile. The C42-SATA module e.g. is equipped with a very fast 1.8-inch SATA Solid State Drive (SSD), which is suitable for installation of any popular operating system.

Related Documents CompactPCI® PlusIO & CompactPCI® Serial

CompactPCI® Serial - Concise Guide	<a href="http://www.ekf.com/s/serial_concise.pdf">www.ekf.com/s/serial_concise.pdf</a>
CompactPCI® Serial - The Smart Solution	<a href="http://www.ekf.com/s/smart_solution.pdf">www.ekf.com/s/smart_solution.pdf</a>
CompactPCI® Serial Home	<a href="http://www.ekf.com/s/serial.html">www.ekf.com/s/serial.html</a>
CompactPCI® PlusIO Home	<a href="http://www.ekf.com/p/plus.html">www.ekf.com/p/plus.html</a>





## Technical Features

### Feature Summary

#### Feature Summary

- ▶ *CompactPCI® Serial* (PICMG® CPCI-S.0) System Slot Controller
- ▶ Based on the Intel® *Chief River* Platform (*Ivy Bridge + ECC* CPU, *Panther Point* PCH)
- ▶ Intel® Core™ i7 (i5/i3) Mobile 3<sup>rd</sup> Generation ECC Processor, 22nm Process Technology, Low Power, Dual-Core and Quad-Core, Code Name *Ivy Bridge*
- ▶ i7-3612QE Processor 2.1GHz • 35W TDP Standard Voltage Quad-Core
- ▶ i7-3555LE Processor 2.5GHz • 25W TDP Low Voltage Dual-Core
- ▶ i7-3517UE Processor 1.7GHz • 17W TDP Ultra Low Voltage Dual-Core
- ▶ *i5-3610ME* Processor 2.7GHz • 35W TDP Standard Voltage Dual-Core
- ▶ *i3-3120ME* Processor 2.4GHz • 35W TDP Standard Voltage Dual-Core
- ▶ *i3-3217UE* Processor 1.6GHz • 17W TDP Ultra Low Voltage Dual-Core
- ▶ Celeron® 1047UE Processor 1.4GHz • 17W TDP Ultra Low Voltage Dual-Core
- ▶ Integrated HD Graphics Engine, 3 Independent Displays, Enhanced Media Processing
- ▶ Integrated Memory Controller up to 16GB DDR3 +ECC 1333 and 1600
- ▶ DDR3 +ECC Soldered Memory up to 8GB
- ▶ DDR3 +ECC SO-DIMM Memory Module Socket up to 8GB
- ▶ Performance Rating Passmark 8.0 SC1-680D (i7-i7-3612QE): Passmark Rating 2241, CPU Rating 7243
- ▶ Intel® *QM77* Platform Controller Hub (PCH), Code Name *Panther Point*
- ▶ Up to 3 Display Configuration (Front Panel: Dual mDP or Single VGA Connector Option)
- ▶ Max Resolution 2560 x 1600 (DisplayPort), 1920 x 1200 (VGA)
- ▶ 2 + 1 SATA Channels 6Gbps/3Gbps for Mezzanine Storage Modules (Connector HSE)
- ▶ CompactFlash® Card with C40-SCFA Mezzanine Module Option (4HP Maintained)
- ▶ CFast™ Card with C41-CFAST Mezzanine Module Option (4HP Profile Maintained)
- ▶ SATA 1.8-Inch Solid State Drive with C42-SATA Mezzanine Card Option (4HP Maintained)
- ▶ Dual mSATA Modules with C47-MSATA RAID Mezzanine Card Option (4HP Maintained)
- ▶ Dual M.2 SATA SSD Modules with C48-M2 RAID Mezzanine Card Option (4HP Maintained)
- ▶ 7 x SATA Channels 3Gbps to Backplane Connectors, 5 Channels Available for Hardware RAID Configuration Level 0/1/10 + Hot Spare (Option RAID Level 3/5)
- ▶ 4 x USB 3.0 XHCI SuperSpeed Channels (2 x to F/P Connectors, 2 x Backplane)
- ▶ 10 x USB 2.0 EHCI (6 x to Mezzanine Connectors, 4 x Backplane)
- ▶ 4 x Gigabit Ethernet Controllers (2 x F/P RJ-45 Jacks and 2 x Backplane Connector)
- ▶ 8 + 8 x PCI Express® Gen3 Lanes to CPCI Serial Backplane (CPCI Serial Fat Pipe 1 + 2)
- ▶ 4 + 4 x PCI Express® Gen2 Lanes (4 x Mezzanine Connector, 4 x Backplane)
- ▶ Legacy I/O Mezzanine Expansion Connector EXP (USB, HD Audio, LPC)
- ▶ High Speed I/O Mezzanine Expansion Connector HSE (3 x SATA, 4 x USB)
- ▶ PCI Express® Mezzanine Expansion Connector PCIE (4 Lanes)
- ▶ Third Display Mezzanine Expansion Connector SDVO/DP
- ▶ Variety of Mezzanine Expansion Boards (Side Cards) Available with and w/o PCIe
- ▶ Most Mezzanines Optionally Equipped with 2.5-Inch Single- or Dual-Drive
- ▶ UEFI Phoenix BIOS with ACPI
- ▶ Long Term Availability
- ▶ Coating, Sealing, Underfilling on Request
- ▶ RoHS compliant
- ▶ Designed & Manufactured in Germany
- ▶ ISO 9001 Certified Quality Management System
- ▶ RT OS BSP & Driver Support - VxWorks 7.0 Available, QNX and Others on Request

## Operating Conditions

Operating Conditions	
Thermal & Environmental Conditions	<ul style="list-style-type: none"> <li>▶ Operating Temperature 0°C to +70°C (-40°C to +85°C on Request)</li> <li>▶ Storage temperature: -40°C to +85°C, max. Gradient 5°C/min</li> <li>▶ Humidity 5% ... 95% RH non Condensing</li> <li>▶ Altitude -300m ... +3000m</li> <li>▶ Shock 15g 0.33ms, 6g 6ms</li> <li>▶ Vibration 1g 5-2000Hz</li> </ul>
EC Regulations	<ul style="list-style-type: none"> <li>▶ EN55022, EN55024, EN60950-1 (UL60950-1/IEC60950-1)</li> <li>▶ 2002/95/EC (RoHS)</li> </ul>
MTBF	104 x 10 <sup>3</sup> h (11.9 years) @ 40° C

## Power Requirements

Power Requirements		
Board	Load Current [A] at +12V (±5%)	
	Maximum Performance LFM / HFM / Turbo <sup>1)</sup>	Windows 7 Idle LFM / HFM / Turbo <sup>1)</sup>
SC1-68XX	3.8 / 4.0 / 4.5 <sup>2)</sup>	1.0 / 1.0 / 1.0 <sup>2)</sup>
SC1-42XX	2.6 / 3.2 / 3.4 <sup>2)</sup>	1.0 / 1.0 / 1.0 <sup>2)</sup>
SC1-22XX	2.5 / 2.6 / 2.6 <sup>2)</sup>	1.0 / 1.0 / 1.0 <sup>2)</sup>
SC1-041X	1.4 / 1.7 / NA	1.0 / 1.0 / NA
	Load Current [A] at +5V[STDBY] (±5%) <sup>3)</sup>	
	Full On / Sleep / Hibernate / Soft Off (S0 / S3 / S4 / S5)	0 / 0 / 0 / 0.1

<sup>1)</sup> Intel SpeedStep Frequency Modes LFM: Low Frequency Mode, HFM: High Frequency Mode.

<sup>2)</sup> Add 60/200mA (link only/active) @1Gbps per Ethernet Port.

<sup>3)</sup> This power supply is optional. It can be left open if not available.

Block Diagram

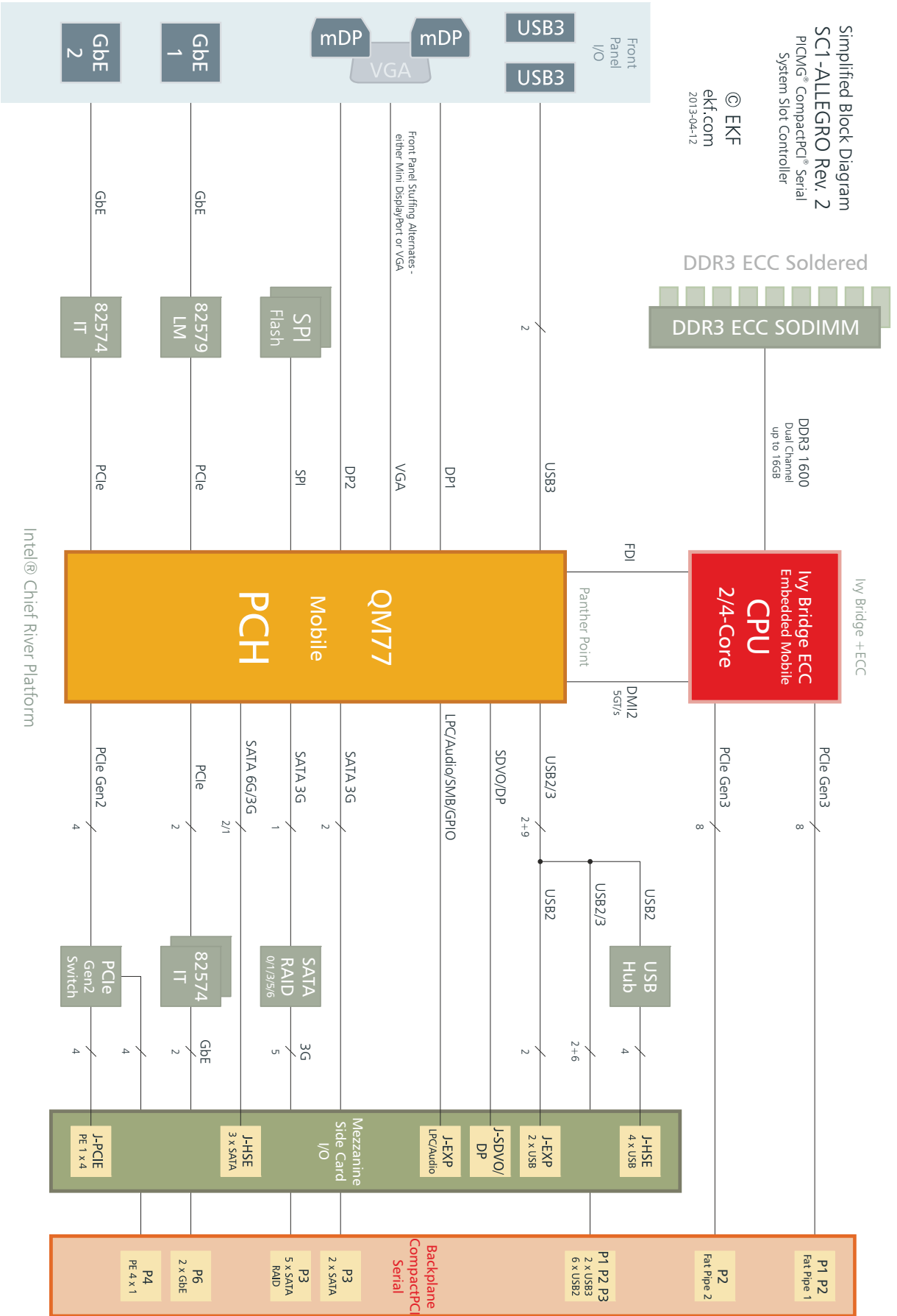

Top View Component Assembly

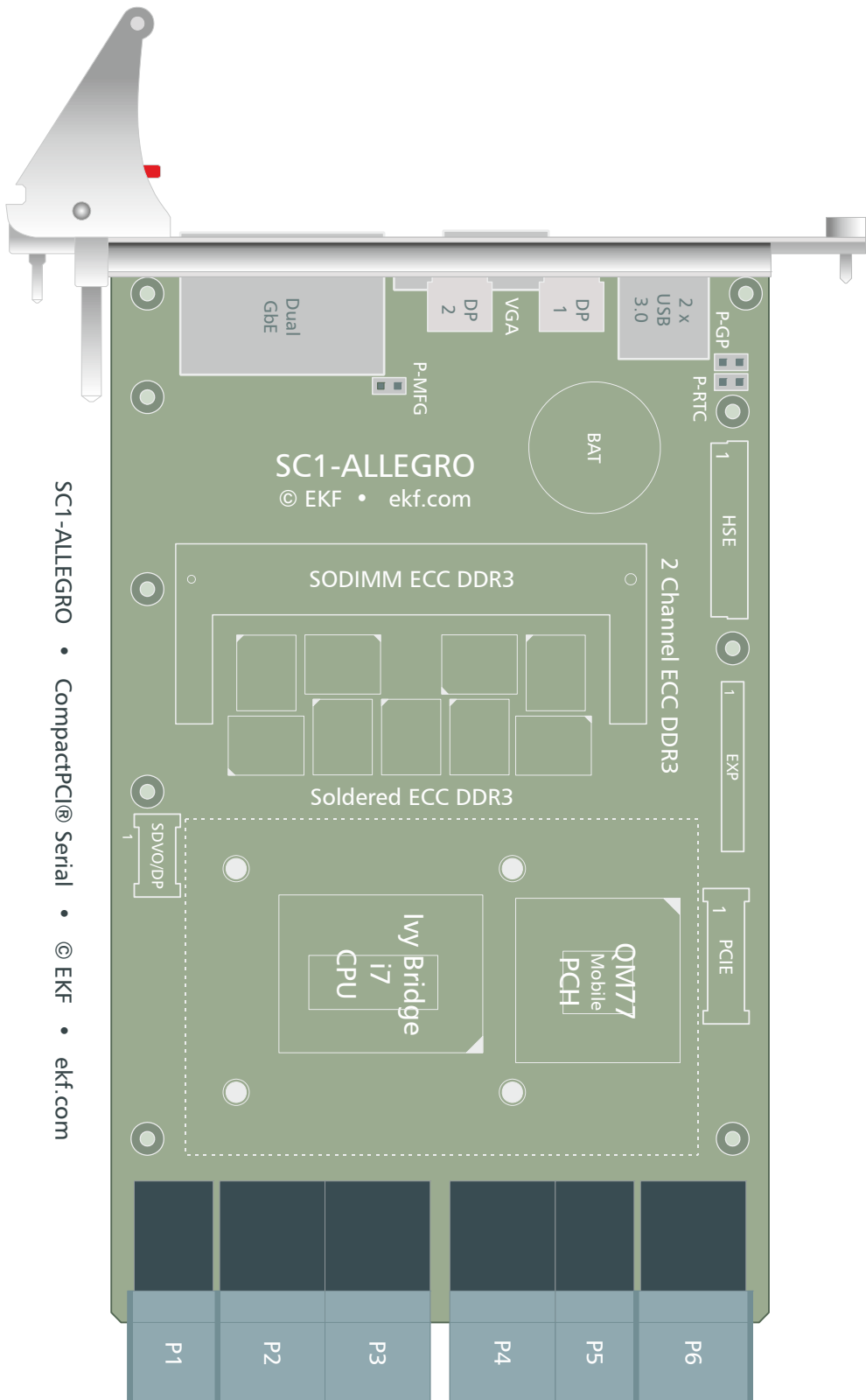

## Front Panel Connectors

ETH1/2	Dual Gigabit Ethernet RJ-45 receptacles with integrated indicator LEDs
mDP1/2	Mini DisplayPort digital video output receptacle (VGA connector available as alternate)
USB1/2	Universal Serial Bus 3.0 type A receptacles
VGA	VGA analog video output connector (Mini DisplayPort connectors available as alternate)

## Front Panel Switches & Indicators

EB	LED indicating Backplane Ethernet activity
FPH	Front Panel Handle with integrated switch (programmable function, power event button by default)
GP	General Purpose bicolour LED
HD	LED indicating any activity on SATA ports
PG	Power Good/Board Healthy bicolour LED
RST	System Reset Button (Option)

## On-Board Connectors & Sockets

J-EXPT J-EXPB <sup>1)</sup>	Utility EXPansion Interface Connector (LPC, USB, HD Audio, SMBus), available either from top (T) or bottom (B) <sup>1)</sup> of the board, interface to optional side board
J-HSE	High Speed Expansion Connector (3 x SATA, 4 x USB), interface to optional low profile mezzanine module or side board
J-PCIE	PCI Express® Expansion Interface Connector, interface to optional side board
J-SDVO	Digital Display Interface Connector (SDVO/DisplayPort)
P1	<i>CompactPCI®</i> Serial Type A Connector
P2-P4	<i>CompactPCI®</i> Serial Type B Connectors
P5	<i>CompactPCI®</i> Serial Type C Connector
P6	<i>CompactPCI®</i> Serial Type D Connector
SODM1	204-pin DDR3 ECC Memory Module SDRAM PC3-12800 Socket (ECC SODIMM)
XDP	CPU Debug Port <sup>1)</sup>

<sup>1)</sup> Connector populated on customers request only

## Pin Headers

P-FPH	Pin header suitable for Front Panel Handle switch cable harness
P-ISP	PLD glue logic device programming connector, not populated

## Jumpers

DS-P	Switches to configure link width and speed on J-PCIE
P-GP	Jumper to reset UEFI BIOS Setup to EKF Factory Defaults
P-MFG	Jumper to enter Manufacturing Mode, not populated
P-RTC	Jumper to reset RTC circuitry (part of PCH), not populated

## Microprocessor

The SC1-ALLEGRO is equipped with Intel® Core™ i7 or i5 3<sup>rd</sup> generation mobile ECC processor (code name Ivy Bridge). These low power processors provide integrated graphics and memory controller, which results in a very efficient platform design. The Core™ processors almost can be considered as a single-chip solution, since all functions of a typical north-bridge have been moved to the CPU.

The Core™ i7 and i5 processor family includes beside the Standard-Voltage (SV) also several Ultra Low-Voltage (ULV) and Low-Voltage (LV) processors as listed below. The processors are housed in a Micro FC-BGA package for direct soldering to the PCB, i.e. the chip cannot be removed or changed by the user.

The processors supported by the SC1-ALLEGRO are running at core clock speeds up to 2.1GHz for quad core and up to 2.5GHz on dual core devices. Due to Enhanced Intel® SpeedStep® and Intel® Turbo Boost Technology each core can decrease or increase its nominal operating frequency. The clock speed is chosen depending on the power states of the processor cores/graphics engine, the currently required performance, and the actual core temperature.

Power is applied across the CompactPCI® connector P1 (12V). The processors core and graphics voltages are generated by switched voltage regulators according to Intels IMVP-7 voltage regulator specification.

Intel® Core™ Processors Supported									
Processor Number	Physical Cores	Core Clock nom./max.	Cache	Gfx Clock	Junction Temp.	TDP	CPU ID	Stepping	SPEC Code
i7-3612QE	4	2.1/3.1GHz	4MB	650MHz	+105°C	35W	306A9h	E-1	SR0ND
i7-3555LE	2	2.5/3.2GHz	4MB	550MHz	+105°C	25W	306A9h	L-1	SR0T5
i7-3517UE	2	1.7/2.8GHz	4MB	350MHz	+105°C	17W	306A9h	L-1	SR0T6
i5-3610ME	2	2.7/3.3GHz	3MB	650MHz	+105°C	35W	306A9h	L-1	SR0QK

## Thermal Considerations

In order to avoid malfunctioning of the SC1-ALLEGRO, take care of appropriate cooling of the processor and system, e.g. by a cooling fan suitable to the maximum power consumption of the CPU chip actually in use. The processor contains digital thermal sensors (DTS) that are readable via special CPU registers. DTS allows to get the temperatures of each CPU core separately.

Two further temperature sensors, located in the system hardware monitor LM87, allows for acquisition of the boards surface temperature and the thermal state of the onboard system memory channel. Beside this the LM87 also monitors most of the supply voltages. A suitable software on Microsoft Windows® systems to display both, the temperatures as well as the supply voltages, is Speedfan, which can be downloaded from the web. After installation, both temperatures and voltages can be observed permanently from the Windows® taskbar.

The SC1-ALLEGRO is equipped with a passive heatsink. Its height takes into account the 4HP limitation in mounting space of a *CompactPC*<sup>®</sup> board. In addition, a forced vertical airflow through the system enclosure (e.g. bottom mount fan unit) is strongly recommended (>20m<sup>3</sup>/h or 2m/s (400LFM) around the CPU slot). Be sure to thoroughly discuss your actual cooling needs with EKF. Generally, the faster the CPU speed the higher its power consumption. For higher ambient temperatures, consider increasing the forced airflow to 3m/s (600LFM) or more.

The table showing the supported processors above give also the maximum power consumption (TDP = Thermal Design Power) of a particular processor. Fortunately, the power consumption is by far lower when executing typical Windows® or Linux tasks. The heat dissipation increases when e.g. rendering software like the Acrobat Distiller is executed.

The Core™ i7 processors support Intel's Enhanced SpeedStep® technology. This enables dynamic switching between multiple core voltages and frequencies depending on core temperature and currently required performance. The processors are able to reduce their core speed and core voltage in multiple steps down to 1200MHz (800MHz for LV/ULV processors). Additionally a reduction of the graphics core clock and voltage is possible. This leads to an obvious reduction of power consumption resulting in less heating. This mode of lowering the processor core temperature is called TM2 (TM=Thermal Monitor).

Another way to reduce power consumption is to modulate the processor clock. This mode (TM1) is achieved by actuating the 'Stop Clock' input of the CPU. A throttling of 50% e.g. means a duty cycle of 50% on the stop clock input. However, while saving considerable power consumption, the data throughput of the processor is also reduced. The processor works at full speed until the core temperature reaches a critical value. Then the processor is throttled by 50%. As soon as the high temperature situation disappears the throttling will be disabled and the processors runs at full speed again.

These features are controllable by BIOS menu entries. By default the BIOS of the SC1-ALLEGRO enables mode TM2 which is the most efficient.





## Main Memory

The SC1-ALLEGRO features two channels of DDR3 SDRAMs with support of ECC (Error Correction Code). One channel is realized with 18 memory devices soldered to the board (Memory Down) and delivers a capacity of up to 8GB with a clock frequency of 1600MHz (PC3-12800).

The 2nd channel provides a socket for installing a 204-pin ECC SODIMM module thus allowing a simple expansion of system memory (max. module height = 1.25 inch). Supported are unbuffered DDR3 ECC SODIMMs (72-bit) with  $V_{DD}=1.5V$  featuring on-die termination (ODT), according the PC3-12800 specification. Minimum module size is 512MB; maximum module size is 8GB. Please note that standard DDR3 SODIMMs without ECC feature do not work on SC1-ALLEGRO.

It is recommended to add a SODIMM module with same size as the Memory Down to get best performance (some of the system memory is dedicated to the graphics controller). This typically results in a size of 2x4GB of memory which is recommended to run the operating systems Windows® Vista or Windows® 7.

The memory controller supports symmetric and asymmetric memory organization. The maximum memory performance can be obtained by using the symmetric mode. When in this mode, the memory controller accesses the memory channels in an interleaved way. Since Core™ i7 processors support Intel's Flex Memory Technology, interleaved operation isn't limited to systems using memory channels of equal capacity. In the case of unequal memory population the smaller memory channel dictates the address space of the interleaved accessible memory region. The remainder of the memory is then accessed in non-interleaved mode.

In asymmetric mode the memory always will be accessed in a non-interleaved manner with the drawback of less bandwidth. The only meaningful application of asymmetric mode is the special case when only one memory channel is populated (i.e. the SODIMM socket may be left empty).

The contents of the SPD EEPROM on the SODIMM is used by the BIOS at POST (Power-on Self Test) to get any necessary timing parameters to program the memory controller within the chipset.

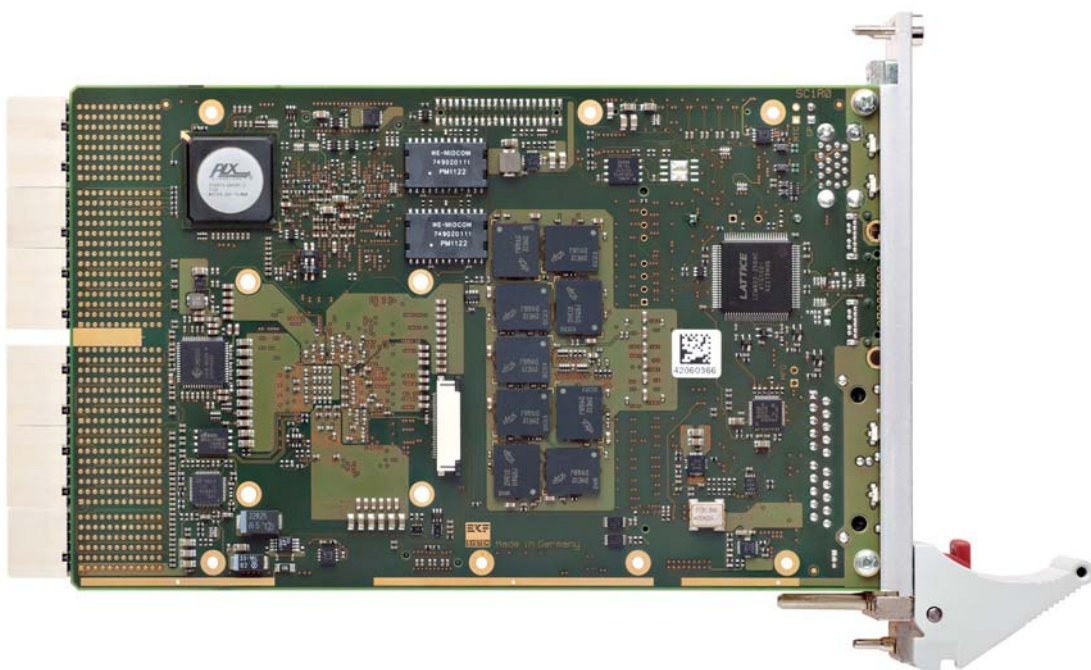

## Graphics Subsystem

The graphics subsystem is part of the Intel Core™ i7 processor and the PCH QM77. While the graphics controller is located within the Core™ i7 processor, the different interfaces like DisplayPort, SDVO and VGA are moved to the PCH. The SC1-ALLEGRO offers two Mini DisplayPort (mDP) interfaces in the front panel.

Adapters to convert Mini DisplayPort to any other popular interface standard are available.

A 3<sup>rd</sup> DisplayPort or an SDVO port is fed in a multiplexed manner to the on-board connector J-SDVO. EKF expansion boards like PCS-BALLET feature the possibility to gain access to the 3<sup>rd</sup> DisplayPort interface. Additionally EKF offers a bundle of expansion boards that contain a display transmitter to provide a DVI channel via a pure digital DVI-D connector.

As an option, the SC1-ALLEGRO can be equipped with an ordinary HD D-Sub 15-lead connector (VGA style). This connector is suitable for analog signals only. Nevertheless also flat-panel displays can be attached to the D-Sub connector but with minor reduced image quality.

Independent from the video connector actually in use, Mini DisplayPort, DVI or VGA, the VESA DDC standard is supported. This allows to read out important parameters, e.g. the maximum allowable resolution, from the attached monitor. DDC Power, +3.3V or +5V on DisplayPort or VGA connector respectively, is delivered via a resettable fuse to protect the board from an external short-circuit condition (0.5A).

Graphics drivers for the Core™ i7 can be downloaded from the Intel web site.

## LAN Subsystem

The Ethernet LAN subsystem is composed of four Gigabit Ethernet ports: One Intel 82579LM Physical Layer Transceiver (PHY) using the PCH QM77 internal MAC and three Intel 82574IT Gigabit Ethernet Controllers. These devices provide also legacy 10Base-T and 100Base-TX connectivity. Two of the Ethernet ports are fed to two RJ45 jacks located in the front panel, the others are attached to the *CompactPCI®* Serial interface on P6. Each port includes the following features:

- ▶ One PCI Express lane per Ethernet port (250MB/s)
- ▶ 1000Base-Tx (Gigabit Ethernet), 100Base-TX (Fast Ethernet) and 10Base-T (Classic Ethernet) capability.
- ▶ Half- or full-duplex operation.
- ▶ IEEE 802.3u, 802.3ab Auto-Negotiation for the fastest available connection.
- ▶ Jumperless configuration (complete software-configurable).

Two bicoloured LEDs integrated into the dedicated RJ-45 connector in the front panel are used to signal the LAN link, the LAN connection speed and activity status. A further bicoloured LED in front panel labelled EB displays the state of the backplane network ports.

Each device is connected by a single PCI Express lane to the PCH. Their MAC addresses (unique hardware number) are stored in dedicated FLASH/EEPROM components. The Intel Ethernet software and drivers for the 82579 and 82574 is available from Intel's World Wide Web site for download.

When managing the board by Intel Active Management Technology (iAMT), the dedicated network port to do so is accessible by the RJ45 connector GbE1 (the upper port within the front panel).

## Serial ATA Interface (SATA)

The SC1-ALLEGRO provides a total of ten serial ATA (SATA) ports, derived from two independent SATA controllers. Two of these ports support data transfer rates of 6Gbps (600MB/s) while all ports are capable to work with 3Gbps (300MB/s) or 1.5Gbps (150MB/s). The SATA controllers are located within the QM77 Platform Controller Hub that holds 6 SATA interfaces.

The two 6Gbps and one 3Gbps ports are fed to the high speed expansion connector J-HSE. This connector allows the installation of low profile expansion boards like C41-CFAST or C42-SATA to attach the popular CFast cards or Micro SATA SSDs (1.8-inch) respectively. Another mezzanine is the C47-MSATA, a carrier for two mSATA SSD modules, that is connected via J-HSE to the 6Gbps ports for fast data storage. Also consider the C48-M2 mezzanine for mass storage, which can accommodate two M.2 style SATA SSD modules.

Another of the 3Gbps ports is fed from the QM77 to a JMicron JMB393 6-port RAID controller supporting RAID levels 0/1/3/5/10 as well as JBOD and CLONE. Five of the JMB393 ports as well as the two remaining QM77 ports are used to supply the *CompactPCI*<sup>®</sup> Serial SATA interfaces on the backplane.

A LED named HD located in the front panel, signals disk activity status of any of the SATA devices.

Additionally a variety of side cards is available, suitable for mounting on the SC1-ALLEGRO in a 4HP (20.32mm) distance (resulting in 8HP front panel width for the assembly). Some of these side boards can accommodate a SATA drive, e.g. a 2.5-inch SSD.

Available for download from Intel's web site are drivers for popular operating systems, e.g. Windows® XP, Windows® Vista, Windows® 7 and Linux.

To manage the RAID configuration of the JMB393 a Windows® application is provided by JMicron that can be downloaded from EKF's website.

## PCI Express® Interface

The SC1-ALLEGRO is provided with several PCI Express (PCIe) lanes for I/O expansion. Sixteen PCI Express lanes, originating from the Core™ i7 processor, are building the two fat pipes defined by *CompactPCI*<sup>®</sup> Serial. These two links consists of eight lanes with transfer rates of up to 8Gbps (PCI Express Gen 3).

The QM77 offers a total of eight PCI Express ports supporting PCIe Gen 2 speed (5GT/s). Four of them form the upstream link to a PCI Express switch. The output ports (downstream ports) of the PCIe switch are connected to the *CompactPCI*<sup>®</sup> Serial connector P4 (four lanes) and to the local PCIe expansion interface connector J-PCIE (four lanes).

Two small DIP switches (DS-P) located on the backside of the board are used to configure different lane widths to each of both downstream interfaces and to choose the interface transfer rate. Possible settings are

- ▶ Four links x 1 lane to *CompactPCI*<sup>®</sup> Serial P4 and a single link x 4 lanes to J-PCIE
- ▶ Four links x 1 lane to *CompactPCI*<sup>®</sup> Serial P4 and four links x 1 lane to J-PCIE
- ▶ 2.5GT/s or 5GT/s transfer speed

See section "Configuration PCI Express Switch (DS-P)" for details.

## Universal Serial Bus (USB)

The SC1-ALLEGRO is provided with fourteen USB ports. All of them are USB 2.0 capable, but four ports are also supporting the USB 3.0 SuperSpeed standard. Two USB 3.0 interfaces are routed to front panel connectors, the other two SuperSpeed ports are feed to the *CompactPCI*<sup>®</sup> Serial connectors P1 and P3.

The USB 2.0 interfaces are distributed to the front panel (two ports), two to the expansion board interface connectors J-EXP, four to the high speed expansion connector J-HSE, and six ports are available across the backplane connectors for *CompactPCI*<sup>®</sup> Serial.

The front panel USB connectors can source a minimum of 1.5A/5V each, over-current protected by two electronic switches. Protection for the USB ports on the expansion interfaces and on the *CompactPCI*<sup>®</sup> Serial connectors is located on expansion boards and the boards on the *CompactPCI*<sup>®</sup> Serial backplane respective. The USB xHCI and two EHCI controllers handling the USB port operation at SuperSpeed, high-speed, full-speed and low-speed are integrated into the QM77 PCH.

## Utility Interfaces

Besides the high speed mezzanine interface connectors J-HSE and J-PCIE, the SC1-ALLEGRO is provided with the utility interface expansion connector socket J-EXP. This connector comprises several interfaces, which may be useful for system expansion on mezzanine cards, as an option:

- ▶ HD Audio
- ▶ LPC (Low Pin Count)
- ▶ SMBus
- ▶ 2 x USB

The SMBus is controlled by the QM77 platform controller hub. The SMBus signal lines on the J-EXP utility expansion connector can be switched on/off under software control (PCH GPIO) in order to isolate external components in case of an I<sup>2</sup>C address conflict.

The HD Audio port requires an additional audio codec, as provided e.g. on the CCO-CONCERT side card.

The LPC bus presents an easy way to add legacy interfaces to the system. EKF offers a variety of mezzanine expansion boards (side cards), to be attached on top of the SC1-ALLEGRO, featuring all classic Super-I/O functionality, for example the CCO-CONCERT. Access to the connectors PS/2 (mouse, keyboard), COM, USB and audio in/out is given directly from the front panel.

## Real-Time Clock

The SC1-ALLEGRO has a time-of-day clock and 100-year calendar, integrated into the QM77 PCH. A battery on the board keeps the clock current when the computer is turned off. The SC1 uses a BR2032 lithium battery soldered in the board, giving an autonomy of more than 5 years. Under normal conditions, replacement should be superfluous during lifetime of the board.

In applications where the use of a battery is not permitted, a SuperCap can be stuffed instead of the battery.

## SPI Flash

The BIOS and iAMT firmware is stored in flash devices with Serial Peripheral Interface (SPI). Up to 16MByte of BIOS code, firmware and user data may be stored nonvolatile in these SPI Flashes.

The SPI Flash contents can be updated by a DOS or Linux based tool. This program and the latest SC1-ALLEGRO BIOS binary are available from the EKF website. Read carefully the enclosed instructions. If the programming procedure fails e.g. caused by a power interruption, the SC1-ALLEGRO may no more be operable. In this case you would possibly have to send in the board, because the Flash device is directly soldered to the PCB and cannot be changed by the user.

## Reset

The SC1-ALLEGRO is provided with several supervisor circuits to monitor supply rails like the CPU core voltage, 1.5V, 3.3V or 5V. This circuitry is responsible also to generate a clean power-on reset signal.

To force a manual board reset, the SC1-ALLEGRO offers a small tactile switch within the front panel. This push-button is indent mounted and requires a tool, e.g. a pen to be pressed, preventing from being inadvertently activated.

The handle within the front panel contains a micro switch that is used to generate a power button event. By pressing the handle's red push button a pulse is triggered.

Animated GIF: [www.ekf.com/c/ccpu/img/reset\\_400.gif](http://www.ekf.com/c/ccpu/img/reset_400.gif)

**NOTE:** To prevent the board to cause a power button override, the handle should be closed immediately after unlocking the front panel handle. A power button override is triggered by opening the front panel handle for at least 4 seconds, which results in bringing the board to power state S5. In case of entering this state, unlock and lock the front panel handle a 2<sup>nd</sup> time to reenter normal power state S0 again. See also section 'PG (Power Good) LED' to see how the SC1-ALLEGRO indicates the different power states.

**WARNING:** The SC1-ALLEGRO will enter the power state S5 if the front panel handle is not closed properly when the system powers up. An open handle is signalled by a yellow blinking 'PG LED'.

The manual reset push-button and the power button functionality of the front panel handle could be passivated by BIOS settings.

An alternative (and recommended) way to generate a system reset is to activate the signal PRST# located on *CompactPCI*<sup>®</sup> Serial connector P1 pin H2. Pulling this signal to GND will have the same effect as to push the tactile reset switch.

The healthy state of the SC1-ALLEGRO is indicated by the LED PG (Power Good) located in the front panel. This bicoloured LED signals different states of the board (see section below). As soon as this LED begins to lite green, all power voltages are within their specifications and the reset signal has been deasserted.

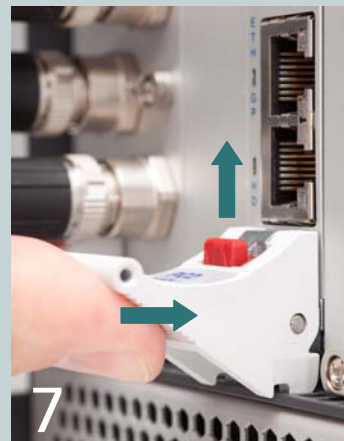
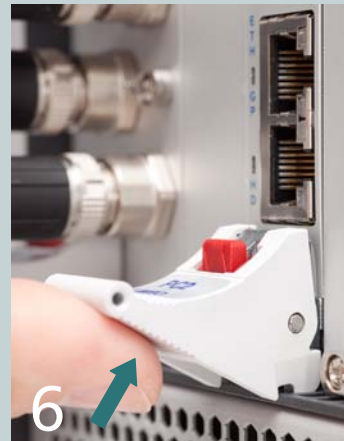

© EKF • ekf.com



## Watchdog

An important reliability feature is a software programmable watchdog function. The SC1-ALLEGRO contains two of these watchdogs. One is part of the QM77 PCH and also known as TCO Watchdog. A detailed description is given in the QM77 data sheet. Operating systems like Linux offer a driver interface to the TCO watchdog.

The behaviour of the 2<sup>nd</sup> watchdog is defined within a PLD of the SC1, which activates/deactivates the watchdog and controls its time-out period. The time-out delay is adjustable in the steps 2, 10, 50 and 255 seconds. After alerting the WD and programming the time-out value, the related software (e.g. application program) must trigger the watchdog periodically. For details on programming the watchdog see section “Board Control and Status Register (BCSR)”.

This watchdog is in a passive state after a system reset. There is no need to trigger it at boot time. The watchdog is activated on the first trigger request. If the duration between two trigger requests exceeds the programmed period, the watchdog times out and a full system reset will be generated. The watchdog remains in the active state until the next system reset. There is no way to disable it once it has been put on alert, whereas it is possible to reprogram its time-out value at any time.

## Front Panel LEDs

The SC1-ALLEGRO is equipped with four LEDs which can be observed from the front panel. Three of these LEDs are labelled according to their primary meaning, but should be interpreted altogether for system diagnosis:

LED			Status
PG Green/Red	GP Green/Red	HD Green/Red	
OFF	GREEN	GREEN	Sleep State S5 (Soft Off)
OFF	GREEN	OFF	Sleep State S4 (Suspend to Disk/Hibernate)
OFF	OFF	GREEN	Sleep State S3 (Suspend to RAM/Standby)
GREEN	RED BLINK	X	After Reset
GREEN	X	X	Board Healthy and in S0 State
YELLOW BLINK	X	X	Front panel handle is unlocked
RED	X	X	Hardware Failure - Power Fault
RED BLINK	X	X	Software Failure

## PG (Power Good) LED

The SC1-ALLEGRO offers a bicolour LED labelled PG located within the front panel. After system reset, this LED defaults to signal different power states:

- ▶ Off                Sleep state S3, S4 or S5
- ▶ Green            Healthy
- ▶ Yellow blink    Front panel handle open
- ▶ Red steady      Hardware failure
- ▶ Red blink       Software failure

To enter the PG LED state *Software Failure*, the bit PGLED in the board control register CTRL\_REG must be set. The PG LED remains in this red blinking state until this bit is cleared. After that it falls back to its default function.

## GP (General Purpose) LED

This programmable bicolour LED can be observed from the SC1-ALLEGRO front panel. The status of the red part within the LED is controlled by the GPIO18 of the PCH QM77. Setting GPIO18 to "1" will switch on the red LED. Turning on or off the green LED is done by setting the bit GPLED in the board control register CTRLH\_REG.

The GP LED is not dedicated to any particular hardware or firmware function with exception of special power states of the LED PG as described above. Nevertheless, a red blinking GP LED is an indication that the BIOS code couldn't start.

While the CPU card is controlled by the BIOS firmware, the GP LED is used to signal board status information during POST (Power On Self Test). After successful operating system boot, the GP LED may be freely used by customer software. For details please refer to [www.ekf.com/s/sc1/firmware/biosinfo.txt](http://www.ekf.com/s/sc1/firmware/biosinfo.txt).

## HD (Hard Disk Activity) LED

The SC1-ALLEGRO offers a bicoloured LED marked as HD placed within the front panel. This LED, when blinking green, signals activity on any device attached to the SATA ports.

The red part of the HD LED isn't used currently.

As previously described, the green part of this LED may change its function dependent on the state of the LED PG.

## EB (Ethernet Backplane) LED

To monitor the link status and activity on both Ethernet ports attached to the backplane via the *CompactPCI*<sup>®</sup> Serial connector P6 a single bicoloured LED is provided in the front panel. The states are decoded as follows:

1_ETH	2_ETH	LED EB
no link	no link	OFF
link	no link	GREEN
no link	link	YELLOW
link	link	GREEN/YELLOW

Blinking of the LED EB in the appropriate colour means that there is activity on the port.

## Main Power Supply Control (PS\_ON#)

The SC1-ALLEGRO draws its power from the +12V main supply rail defined by the *CompactPCI*<sup>®</sup> Serial specification. The board has been designed to control this main power supply by use of the signal PS\_ON# (connector P1 pin E2). If the system enters the sleep state S5 (soft off), the signal PS\_ON# is pulled high, hence the main power supply is switched-off. The SC1-ALLEGRO is held in soft off state until a power management event (e.g. power button event triggered by the front panel handle) brings back the system to the S0 state.

In order to work as described above and to generate clean signals on PS\_ON#, the stand-by voltage +5VSTB is necessary. This optional power rail, tied to connector P1 pin B1, is also part of the *CompactPCI*<sup>®</sup> Serial specification. The stand-by power rail must be switched-on “always”, independent of the state of PS\_ON#.

Nevertheless, +5VSTB is not mandatory to operate the SC1-ALLEGRO. If no stand-by power is available, the board creates this voltage from the main power rail. In this case it is important that the PS\_ON# signal is pulled down somewhere in the system.

## Power Supply Status (PWR\_FAIL#)

Power supply failures may be detected before the system crashes down by monitoring the signal PWR\_FAIL#. This active low line (connector P1 pin F3) is an addition to the *CompactPCI*<sup>®</sup> Serial specification and may be driven by the power supply. PWR\_FAIL# signals the possible failure of the main supply voltage +12V. On the SC1-ALLEGRO the signal PWR\_FAIL# is routed to GPIO6 of the QM77 PCH to analyse the state of the power supply unit.

## Mezzanine Side Board Options

The SC1-ALLEGRO is provided with several stacking connectors for attachment of a mezzanine expansion module (aka side board), suitable for a variety of readily available mezzanine cards (please refer to [www.ekf.com/c/ccpu/mezz\\_ovw.pdf](http://www.ekf.com/c/ccpu/mezz_ovw.pdf) for a more comprehensive overview). EKF furthermore offers custom specific development of side boards (please contact [sales@ekf.de](mailto:sales@ekf.de)).

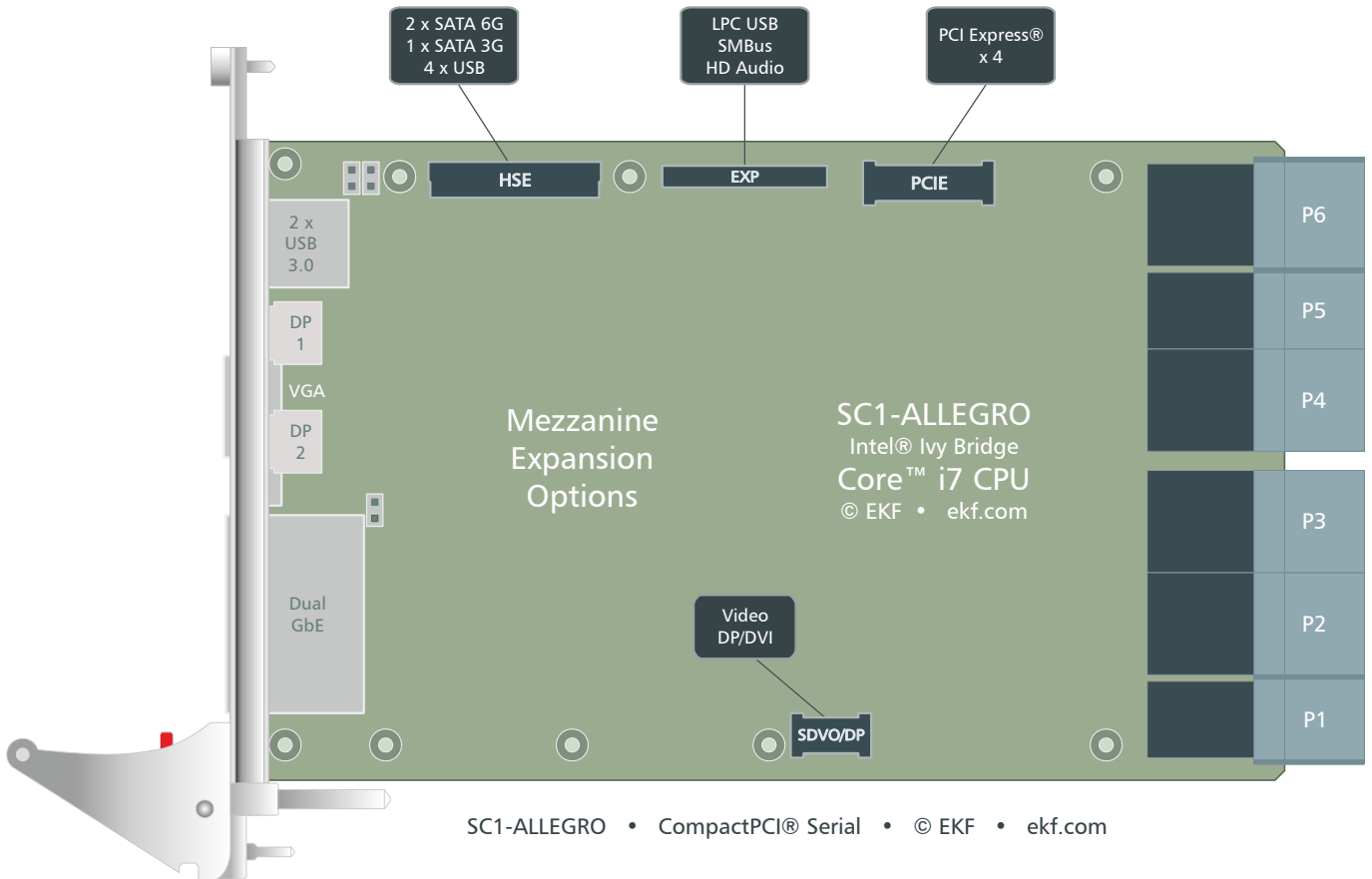

Most mezzanine expansion modules require an assembly height of 8HP in total, together with the CPU carrier board (resulting from two cards at 4HP pitch each).

In addition, cropped low profile mass storage mezzanine modules can be attached to J-HSE, which maintain the 4HP envelope, for extremely compact systems. Furthermore these small size modules may be combined with the full-size expansion boards (that means an assembly comprised of 3 PCBs).

Related Documents Mezzanine Modules and Side Cards	
C4x Series Mezzanine Storage Modules	<a href="http://www.ekf.com/c/ccpu/c4x_mezz_ovw.pdf">www.ekf.com/c/ccpu/c4x_mezz_ovw.pdf</a>
Mezzanine Modules Overview	<a href="http://www.ekf.com/c/ccpu/mezz_ovw.pdf">www.ekf.com/c/ccpu/mezz_ovw.pdf</a>
The EKF Mezzanine Module Concept	<a href="http://www.ekf.com/c/ccpu/cpci_mezzanine_evolution.pdf">www.ekf.com/c/ccpu/cpci_mezzanine_evolution.pdf</a>

J-EXP	
I/F Type	Controller
LPC (Low Pin Count)	CPU
HD Audio	CPU
SMBus	CPU (buffered)
2 x USB 2.0	PCH

J-HSE	
I/F Type	Controller
SATA1	PCH 3GT/s
SATA2, SATA3	PCH 6GT/s
4 x USB 2.0	USB Hub

J-PCIE	
I/F Type	Controller
PCI Express®	PE Switch

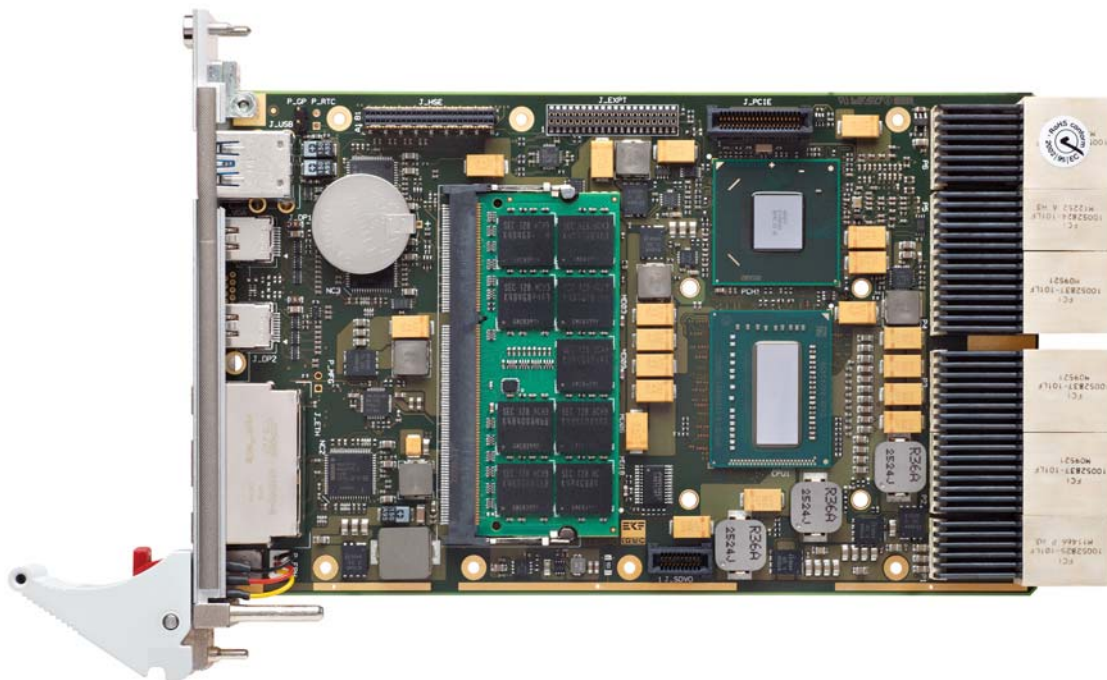



SC1-ALLEGRO with C42-SATA Low Profile Storage Module



4HP Front Panel Width with C42-SATA



SC1-ALLEGRO with C47-MSATA Low Profile Storage Module



4HP Front Panel Width with C47-MSATA



4HP Front Panel Width Assembly w. C48-M2



SC1-ALLEGRO with C48-M2 Dual M.2 SATA SSD Module





SC1-ALLEGRO with C44-SATA Assembly (8HP Front Panel)



SC1-ALLEGRO with C45-SATA Assembly (8HP Front Panel)



SC1-ALLEGRO with C43-SATA (Internal Connectors)



SC1-ALLEGRO with C41-CFAST Low Profile Storage Module

## *CompactPCI*<sup>®</sup> Serial

### System Slot Controller

The PICMG<sup>®</sup> *CompactPCI*<sup>®</sup> Serial specification defines a card slot system based on the modern high speed data-links PCI Express<sup>®</sup>, SATA, Ethernet and USB. The SC1-ALLEGRO, designed to act as a *CompactPCI*<sup>®</sup> Serial system slot controller, provides the resources of these interfaces. The backplane distributes them in the form of point to point connections to the peripheral slots.

The SC1-ALLEGRO allocates most but not all communication channels defined by *CompactPCI*<sup>®</sup> Serial on the backplane:

- ▶ Two PCIe Links x8, 2.5GT/s, 5GT/s or 8GT/s (Fat Pipes)
- ▶ Four PCIe Links x1, 2.5GT/s or 5GT/s
- ▶ Seven SATA Ports 3GT/s
- ▶ Two USB 3.0 Ports
- ▶ Six USB 2.0 Ports
- ▶ Two Gigabit Ethernet Ports

These resources may be distributed on a typical 9-slot *CompactPCI*<sup>®</sup> Serial backplane as follows:

SC1-ALLEGRO Rev. 2 • Resources w. 1 + 8 Slots Backplane (System Slot Left)

	1	2	3	4	5	6	7	8	9
P6	SYS GBE (1-2)	GBE (1)	GBE (2)						
P5	CLK PE (1-6)								
P4	PE Gen2 4 x 1 (3-6)	PER 1	PER 2	PER 3	PER 4	PER 5	PER 6	PER 7	PER 8
P3	SATA 3G 2 x PCH 5 x RAID 1 x USB3 3 x USB2							SATA 3G (PCH)	SATA 3G (PCH)
P2	PE Gen3 1 x 8 (2) 1/2 x 8 (1) 3 x USB2 I/O								
P1	PE Gen3 1/2 x 8 (1) 1 x USB3 Sideband	PE Gen3 1 x 8 (1) USB3	PE Gen3 1 x 8 (2) SATA 3G (RAID) USB3	PE Gen2 x 1 SATA 3G (RAID) USB2	PE Gen2 x 1 SATA 3G (RAID) USB2	PE Gen2 x 1 SATA 3G (RAID) USB2	PE Gen2 x 1 SATA 3G (RAID) USB2	SATA 3G (PCH)	SATA 3G (PCH)
	SC1-ALLEGRO	Fat Pipe Slot	Fat Pipe Slot	Peripheral Slot	Peripheral Slot	Peripheral Slot	Peripheral Slot	Peripheral Slot	Peripheral Slot

© EKF • ekf.com

Note: The Assignment of the SATA Resources has changed with Revision 2 of the SC1-ALLEGRO. See sections "CompactPCI Serial Backplane Connector P3" for details.



SC1-ALLEGRO on a Backplane w. System Slot Left Aligned

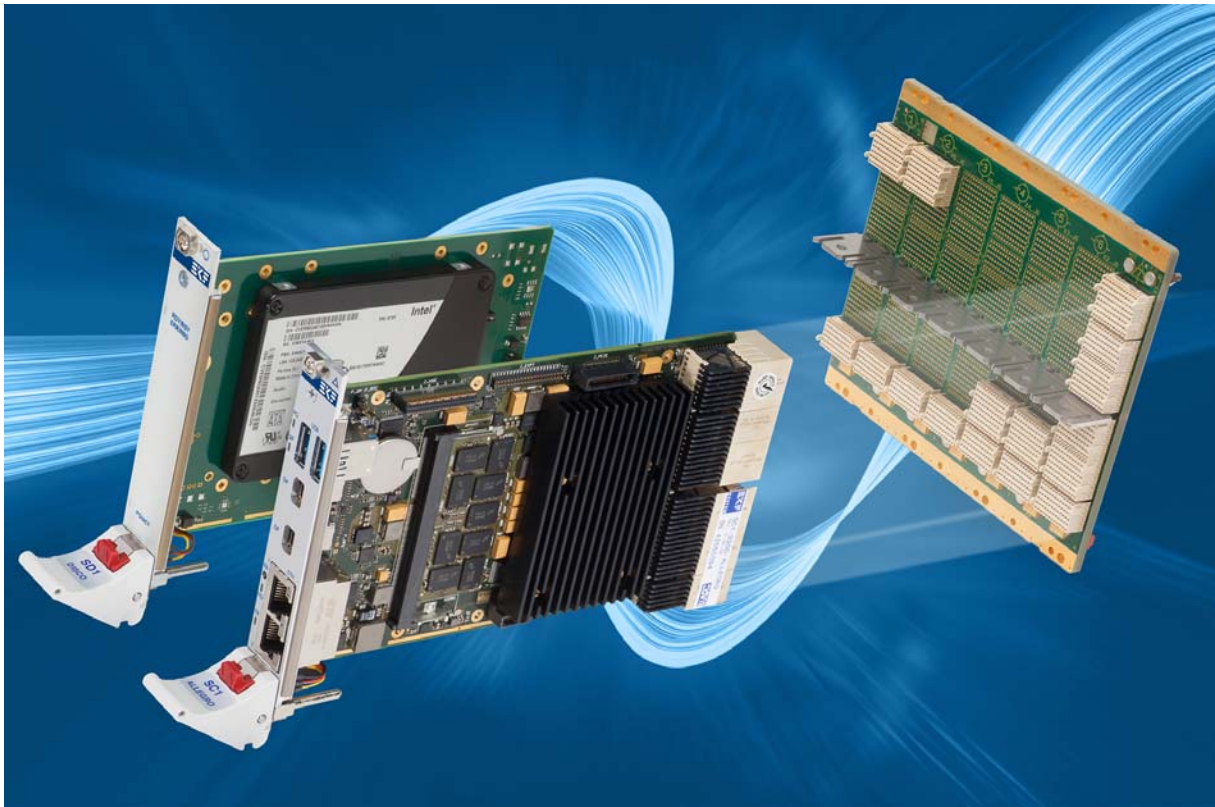

Backplane w. System Slot Right Aligned

SC1-ALLEGRO Rev. 2 • Resources w. 1 + 8 Slots Backplane (System Slot Right)

	①	②	③	④	⑤	⑥	⑦	⑧	⑨
							GBE (2)	GBE (1)	SYS
P6									GBE (1-2)
P5									CLK PE (1-6)
P4	PER 8	PER 7	PER 6	PER 5	PER 4	PER 3	PER 2	PER 1	PE Gen2 4 x 1 (3-6)
P3									SATA 3G 2 x PCH 5 x RAID 1 x USB3 3 x USB2
P2									PE Gen3 1 x 8 (2) 1/2 x 8 (1) 3 x USB2 I/O
P1	SATA 3G (PCH)	SATA 3G (PCH)	PE Gen2 x 1 SATA 3G (RAID) USB2	PE Gen2 x 1 SATA 3G (RAID) USB2	PE Gen2 x 1 SATA 3G (RAID) USB2	PE Gen2 x 1 SATA 3G (RAID) USB2	PE Gen3 1 x 8 (2) SATA 3G (RAID) USB3	PE Gen3 1 x 8 (1) USB3	PE Gen3 1/2 x 8 (1) 1 x USB3 Sideband
	Peripheral Slot	Peripheral Slot	Peripheral Slot	Peripheral Slot	Peripheral Slot	Peripheral Slot	Fat Pipe Slot	Fat Pipe Slot	SC1-ALLEGRO

© EKF • ekf.com

## Peripheral Slot Operation

Beyond that the SC1-ALLEGRO is operable in periphery slots as well. In this case it acts as a satellite system, linked to other (processor-) boards by its backplane Ethernet connections. The other resources associated with the backplane like PCI Express, SATA or USB are not usable in this situation.

Some of the following, system slot dedicated control signals get an altered function or will be disconnected from the backplane:

- ▶ PWRBTN# (Connector P1 Pin C3) will be disconnected
- ▶ PWR\_FAIL# (Connector P1 Pin F3) becomes GA1
- ▶ PRST# (Connector P1 Pin H2) becomes RST# and will be disconnected
- ▶ WAKE# (Connector P1 Pin I2) will be disconnected
- ▶ SGPIO (Connector P1 Pins G3/H3/J3/K3) will be disconnected

One result of that is, that a SC1-ALLEGRO plugged into a peripheral slot will not get a reset even if the system controller forces the reset signal on the backplane to an active state.

## Board Hot-Plug

Hot-plug of the SC1-ALLEGRO is not supported, no matter whether it is working as a system controller or satellite board.



SC1-ALLEGRO as System Slot Controller for CompactPCI® Serial Systems



CompactPCI® Serial Rack



BluBoxx Series Small Systems Rack



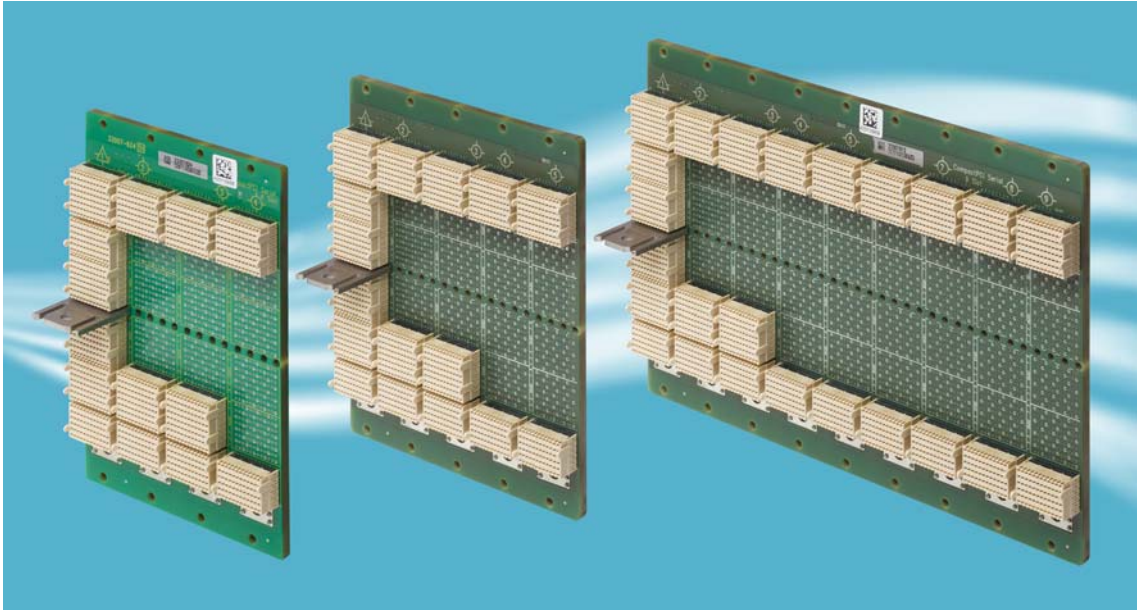

CompactPCI® Serial Backplanes

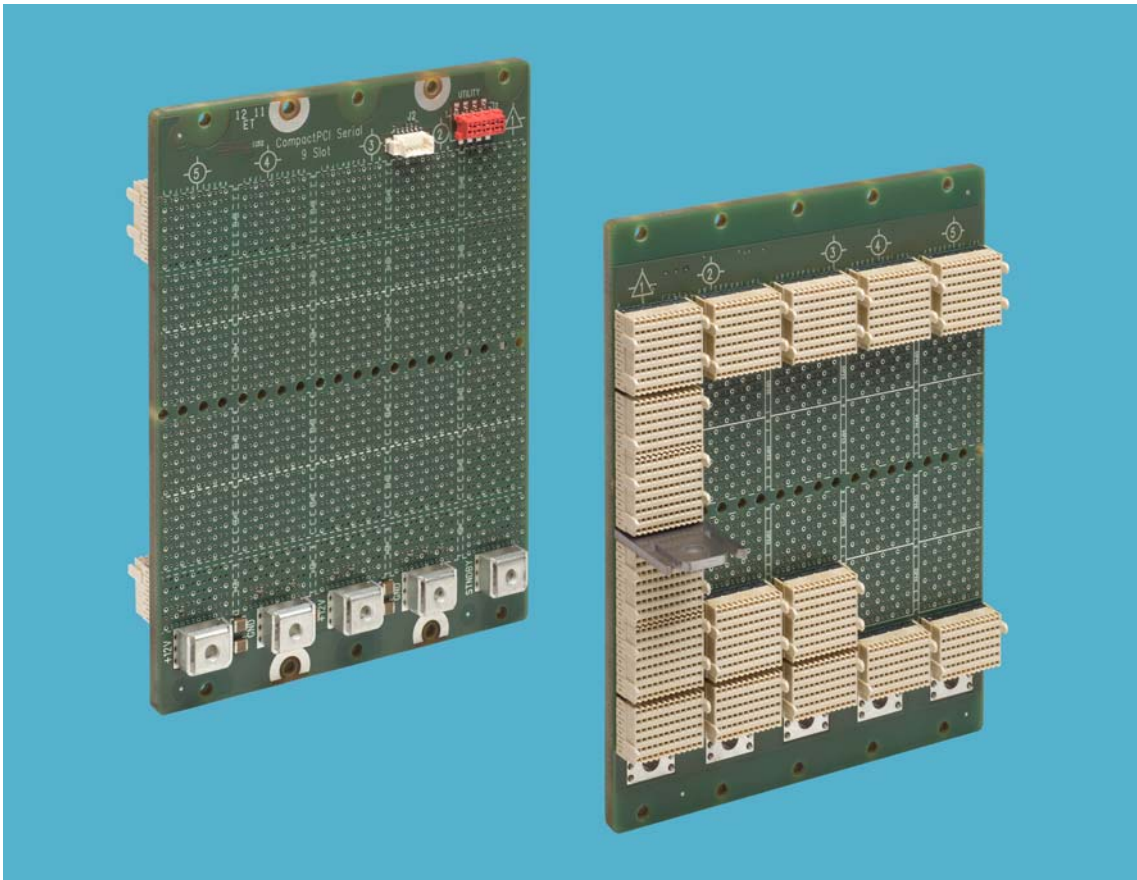

1 + 4 Slots CompactPCI® Serial Backplane

## Installing and Replacing Components

### Before You Begin

#### Warnings

The procedures in this chapter assume familiarity with the general terminology associated with industrial electronics and with safety practices and regulatory compliance required for using and modifying electronic equipment. Disconnect any telecommunication links, networks or procedures described in this chapter. Failure links before you open the system or perform or equipment damage. Some parts of the the power switch is in its off state.



the system from its power source and from modems before performing any of the to disconnect power, or telecommunication any procedures can result in personal injury system can continue to operate even though

#### Caution

Electrostatic discharge (ESD) can damage components. Perform the procedures described in this chapter only at an ESD workstation. If such a some ESD protection by wearing an metal part of the system chassis or board original ESD protected packaging. Retain the antistatic box) in case of returning the board to EKF for repair.



station is not available, you can provide antistatic wrist strap and attaching it to a front panel. Store the board only in its original packaging (antistatic bag and

## Installing the Board

### Warning

This procedure should be done only by qualified technical personnel. Disconnect the system from its power source before doing the procedures described here. Failure to disconnect power, or telecommunication links before you open the system or perform any procedures can result in personal injury or equipment damage.

Typically you will perform the following steps:

- Switch off the system, remove the AC power cord
- Attach your antistatic wrist strap to a metallic part of the system
- Remove the board packaging, be sure to touch the board only at the front panel
- Identify the related *CompactPCI*<sup>®</sup> slot (peripheral slot for I/O boards, system slot for CPU boards, with the system slot typically most right or most left to the backplane)
- Insert card carefully (be sure not to damage components mounted on the bottom side of the board by scratching neighbored front panels)
- A card with onboard connectors requires attachment of associated cabling now
- Lock the ejector lever, fix screws at the front panel (top/bottom)
- Retain original packaging in case of return



## Removing the Board

### Warning

This procedure should be done only by qualified technical personnel. Disconnect the system from its power source before doing the procedures described here. Failure to disconnect power, or telecommunication links before you open the system or perform any procedures can result in personal injury or equipment damage.

Typically you will perform the following steps:

- Switch off the system, remove the AC power cord
- Attach your antistatic wrist strap to a metallic part of the system
- Identify the board, be sure to touch the board only at the front panel
- Unfasten both front panel screws (top/bottom), unlock the ejector lever
- Remove any onboard cabling assembly
- Activate the ejector lever
- Remove the card carefully (be sure not to damage components mounted on the bottom side of the board by scratching neighbored front panels)
- Store board in the original packaging, do not touch any components, hold the board at the front panel only



### Warning

Do not expose the card to fire. Battery cells and other components could explode and cause personal injury.





## EMC Recommendations

In order to comply with the CE regulations for EMC, it is mandatory to observe the following rules:

- The chassis or rack including other boards in use must comply entirely with CE
- Close all board slots not in use with a blind front panel
- Front panels must be fastened by built-in screws
- Cover any unused front panel mounted connector with a shielding cap
- External communications cable assemblies must be shielded (shield connected only at one end of the cable)
- Use ferrite beads for cabling wherever appropriate
- Some connectors may require additional isolating parts

## Recommended Accessories

Blind CPCI Front Panels	EKF Elektronik	Widths currently available (1HP=5.08mm): with handle 4HP/8HP without handle 2HP/4HP/8HP/10HP/12HP
Ferrit Bead Filters	ARP Datacom, 63115 Dietzenbach	Ordering No. 102 820 (cable diameter 6.5mm) 102 821 (cable diameter 10.0mm) 102 822 (cable diameter 13.0mm)
Metal Shielding Caps	Conec-Polytronic, 59557 Lippstadt	Ordering No. CDFA 09 165 X 13129 X (DB9) CDSFA 15 165 X 12979 X (DB15) CDSFA 25 165 X 12989 X (DB25)

## Replacement of the Battery

When your system is turned off, a battery maintains the voltage to run the time-of-day clock and to keep the values in the CMOS RAM. The battery should last during the lifetime of the SC1-ALLEGRO. For replacement, the old battery must be desoldered, and the new one soldered. We suggest that you send back the board to EKF for battery replacement.

### Warning

Danger of explosion if the battery is incorrectly replaced or shorted. Replace only with the same or equivalent type. Do not expose a battery to fire.



## Technical Reference

### Local PCI Devices

The following table shows the on-board PCI devices and their location within the PCI configuration space. Several devices are part of the processor and platform controller hub QM77.

Bus #	Device #	Function #	Vendor ID	Device ID	Description
0	0	0	0x8086	0x0154	Processor Host Bridge/DRAM Controller
0	1	0	0x8086	0x0151	Processor PCI Express Controller
0	2	0	0x8086	0x0156	Processor Integrated Graphics Device
0	6	0	0x8086	0x015D	Processor PCI Express Controller
0	20	0	0x8086	0x1E31	USB xHCI Controller
0	22	0	0x8086	0x1E3A	Intel ME Interface #1
0	22	1	0x8086	0x1E3B	Intel ME Interface #2
0	22	2	0x8086	0x1E3C	Intel ME IDE Redirection
0	22	3	0x8086	0x1E3D	Intel ME Keyboard Text Redirection
0	25	0	0x8086	0x1502	PCH Gigabit LAN NC1 (82579LM)
0	26	0	0x8086	0x1E2D	USB EHCI Controller #2
0	27	0	0x8086	0x1E20	Intel High Definition Audio Controller
0	28	0-7	0x8086	0x2448	PCH PCI Express Port 1-8
0	29	0	0x8086	0x1E26	USB EHCI Controller #1
0	31	0	0x8086	0x1E55	LPC Bridge
0	31	2	0x8086	0x1E01 0x1E03 0x282A 0x1E07	SATA: Non-AHCI/RAID (Ports 0-3) <sup>1)</sup> SATA: AHCI Mode <sup>1)</sup> SATA: Intel Rapid Storage Tech. RAID Mode <sup>1)</sup> SATA: RAID Mode Capable <sup>1)</sup>
0	31	3	0x8086	0x1E22	SMBus Controller
0	31	5	0x8086	0x1E09	SATA: Non-AHCI/RAID (Ports 4/5)
0	31	6	0x8086	0x1E24	Thermal Controller
2 <sup>2)</sup>	00	0	0x8086	0x10D3	Ethernet Controller NC2 (82574IT)
3 <sup>2)</sup>	00	0	0x8086	0x10D3	Ethernet Controller NC3 (82574IT)
4 <sup>2)</sup>	00	0	0x8086	0x10D3	Ethernet Controller NC4 (82574IT)
5 <sup>2)</sup>	00	0	0x10B5	0x8614	PCIe Switch Root Port (PEX8614)
6 <sup>2)</sup>	01,02,04 ...	0	0x10B5	0x8614	PCIe Switch Downstream Ports (PEX8614)

<sup>1)</sup> Depends on BIOS settings.

<sup>2)</sup> Bus number can vary depending on the PCI enumeration schema implemented in BIOS.

## Local SMB Devices

The SC1-ALLEGRO contains devices that are attached to the System Management Bus (SMBus). These are the SPD EEPROMs for the on-board memory or the possibly plugged SODIMM, a general purpose serial EEPROM, a supply voltage/temperature controlling device and a set of board control and status registers. Additional devices may be connected to the SMBus via the *CompactPCI*<sup>®</sup> Serial backplane signals I<sup>2</sup>C\_SCL (P1 B2) and I<sup>2</sup>C\_SDA (P1 B3), or pins 29/30 of the mezzanine expansion connector J-EXP.

Address	Description
0x58	Hardware Monitor/Memory Down Temperature Sensor (LM87)
0x5C	Board Control/Status
0xA0	SPD of On-board Memory
0xA4	SPD of SODIMM
0xAE	General Purpose EEPROM

## Hardware Monitor LM87

Attached to the SMBus, the SC1-ALLEGRO is provided with a hardware monitor (LM87). This device is capable to observe the board and on-board memory temperatures, as well as several supply voltage rails with a resolution of 8 bit. The following table shows the mapping of the voltage inputs of the LM87 to the corresponding supply voltages of the SC1-ALLEGRO:

Input	Source	Resolution [mV]	Register
AIN1	Processor Core Voltage	9.8	0x28
AIN2	Graphics Core Voltage	9.8	0x29
VCCP1	+1.5V	14.1	0x21
VCCP2/D2-	+1.8V	14.1	0x25
+2.5V/D2+	+1.05V	13	0x20
+3.3V	+3.3V	17.2	0x22
+5V	+5V	26	0x23
+12V	+12V	62.5	0x24

Beside the continuous measuring of temperatures and voltages the LM87 may compare these values against programmable upper and lower boundaries. As soon as a measurement violates the allowed value range, the LM87 can request an interrupt via the GPI13 input of the QM77 PCH (which may result in a system management interrupt).



## Board Control and Status Registers

A set of board control and status registers allow to program special features on the SC1-ALLEGRO:

- ▶ Assert a full reset
- ▶ Control activity of front panel reset and power event button
- ▶ Program time-outs and trigger a watchdog
- ▶ Get access to two LEDs in the front panel
- ▶ Get power fail and watchdog status of last board reset

The register set consists of five registers located on the SMBus at Device ID=0x5c on the following addresses:

- ▶ 0xA0: CMD\_CTRL0\_WR: Write to Control Register 0 (Write-Only)
- ▶ 0xA1: CMD\_CTRL0\_RD: Read from Control Register 0 (Read-Only)
- ▶ 0xB0: CMD\_STAT0\_WR: Write to Status Register 0 (Write-Clear)
- ▶ 0xB1: CMD\_STAT0\_RD: Read from Status Register 0 (Read-Only)
- ▶ 0xB2: CMD\_STAT1\_WR: Write to Status Register 1 (Write-Clear)
- ▶ 0xB3: CMD\_STAT1\_RD: Read from Status Register 1 (Read-Only)
- ▶ 0xC1: CMD\_PLDREV\_RD: Read from PLD Revision Register (Read-Only)

To prevent malfunction accesses to the registers should be done by SMBus “Byte Data” commands. Further writes to read-only or reads to write-only registers should be omitted.

### Write/Read Control Register 0

Write: SMBus Address 0xA0

Default after reset: 0x00

Read: SMBus Address 0xA1

Bit	Description CMD_CTRL0
7	<b>GPLED</b> 0=Green part of the front panel LED GP is off (Default) 1=Green part of the front panel LED GP is on
6	<b>FPDIS</b> 0=Enable the front panel handle switch (Default) 1=Disable the front panel handle switch
5	<b>FERP#</b> 0=The front panel handle switch generates a power event (Default) 1=The front panel handle switch generates a system reset
4:3	<b>WDGT0:WDGT1</b> Maximum Watchdog retrigger time: 0:0 2 sec 1:0 10 sec 0:1 50 sec 1:1 250 sec
2	<b>WDGTRG</b> Retrigger Watchdog. Any change of this bit will retrigger the watchdog. After a system reset the watchdog is in an inactive state. The watchdog is armed on the 1 <sup>st</sup> edge of this bit.
1	<b>PGLED</b> 0=Red part of the front panel LED PG is off (Default) 1=Red part of the front panel LED PG is blinking

Bit	Description CMD_CTRL0
0	<b>SRES</b> 0=Normal operation (Default) 1=A full system reset is performed

## Read/Clear Status Register 0

Write: SMBus Address 0xB0

Read: SMBus Address 0xB1

Bit	Description CMD_STAT0
7	<b>PF18S</b> 0=Normal operation 1=Last system reset may be caused by a power failure of the +V1.8S voltage regulator
6	<b>PF15S</b> 0=Normal operation 1=Last system reset may be caused by a power failure of the +V1.5S voltage regulator
5	<b>PF13S</b> 0=Normal operation 1=Last system reset may be caused by a power failure of the +V1.3S voltage regulator
4	<b>PFVSA</b> 0=Normal operation 1=Last system reset may be caused by a power failure of the CPU +VCC_SA voltage regulator
3	<b>PF105L</b> 0=Normal operation 1=Last system reset may be caused by a power failure of the +V1.05LAN voltage regulator
2	<b>PF105S</b> 0=Normal operation 1=Last system reset may be caused by a power failure of the +V1.05S voltage regulator
1	<b>PFVRG</b> 0=Normal operation 1=Last system reset may be caused by a power failure of the CPU +VCC_AXG voltage regulator
0	<b>PFVRC</b> 0=Normal operation 1=Last system reset may be caused by a power failure of the CPU +VCC_CPU voltage regulator

The bits in this register are sticky, i.e. their state will be kept even if a system reset occurs. To clear the bits a write to the register with arbitrary data may be performed.

## Read/Clear Status Register 1

Write: SMBus Address 0xB2

Read: SMBus Address 0xB3

Bit	Description CMD_STAT1
7	<b>RESERVED</b> Always read as 0
6	<b>WDGRST</b> 0=Normal operation 1=Last system reset may be caused by a watchdog time-out
5	<b>WDGHT</b> 0=Normal operation 1=The watchdog already has elapsed half of its time-out period
4	<b>PF5PS</b> 0=Normal operation 1=Last system reset may be caused by a power failure of the +V5PS voltage regulator
3	<b>PF133S</b> 0=Normal operation 1=Last system reset may be caused by a power failure of the +V1.05S or +V3.3S voltages
2	<b>PF133M</b> 0=Normal operation 1=Last system reset may be caused by a power failure of the +V1.05M or +V3.3M voltages
1	<b>PF33A</b> 0=Normal operation 1=Last system reset may be caused by a power failure of the +V3.3A voltage regulator
0	<b>PF33S</b> 0=Normal operation 1=Last system reset may be caused by a power failure of the +V3.3S voltage regulator

Except of WDGHT the bits in this register are sticky, i.e. their state will be kept even if a system reset occurs. To clear the bits a write to the register with arbitrary data may be performed.

## Read PLD Revision Register

Write: Not allowed

Read: SMBus Address 0xC1

Bit	Description CMD_PLDREV
7:0	<b>PLDREV</b> Read PLD Revision Number

## GPIO Usage

## GPIO Usage QM77 PCH

GPIO Usage QM77 PCH				
GPIO	Type	Tol.	Function	Description
GPIO 0	I	3.3V	THRM_ALERT#	Monitoring of processor PROCHOT#
GPIO 1	I	3.3V	EXP_SMI#	Expansion Interface SMI Request (J-EXP Pin 15)
GPIO 2-4	I	5V	HWREV	PCB Revision Code HWREV[2:0]: GPIO[4:2]      000    001    010    ...    111 Revision        0      1      2      ...    7
GPIO 5	I	5V	PM_MEMTS#	Memory Thermal Sensor Event
GPIO 6	I	3.3V	CPCI_PWR_FAIL#	Sense CompactPCI® Serial Power Failure Line PWR_FAIL#
GPIO 7	I	3.3V	CPCI_SYSEN#	Sense CompactPCI® System Slot Enable Line SYSEN#
GPIO 8	O	3.3V	SPM_CFG_SET	JMB393 RAID Controller: Configuration MODE2 <sup>1)</sup>
GPIO 9	I	3.3V	USB_OC5#	USB J-HSE Port 2 Overcurrent Detect
GPIO 10	I	3.3V	USB_OC6#	USB J-HSE Port 3 or 4 Overcurrent Detect
GPIO 11	I	3.3V	GP_JUMP#	Reset UEFI BIOS Setup to Factory Defaults, Jumper P-GP
GPIO 12	O	3.3V	NC1_ENABLE	Enable Ethernet Controller NC1
GPIO 13	I	3.3V	HM_INT#	Hardware Monitor LM87 Interrupt Line
GPIO 14	I	3.3V	USB_OC7#	USB J-EXP Port 1 or 2 Overcurrent Detect
GPIO 15	O	3.3V	SPM_MODE0	JMB393 RAID Controller: Configuration MODE0
GPIO 16	O	3.3V	MODE_DP_SDVO#	Switch Mode of J-SDVO Connector LOW: J-SDVO in SDVO Mode HIGH: J-SDVO in DisplayPort Mode
GPIO 17	I	3.3V	N/A	Not used on SC1 (pulled via resistor to GND)
GPIO 18	O	3.3V	GP_LED_RED	General Purpose Red LED Control (via PLD)
GPIO 19	I	3.3V	N/A	Not used on SC1 (pulled via resistor to +3.3V)
GPIO 20	O	3.3V	SE_SYS_WP	General Purpose Serial EEPROM Write Protection
GPIO 21	O	3.3V	N/A	Not used on SC1 (pulled via resistor to +3.3V)
GPIO 22	O	3.3V	SGPIO_CLOCK	Serial GPIO Bus CLOCK (P1 J3: SATA_SCL)
GPIO 23	I	3.3V	N/A	Not used on SC1
GPIO 24	O	3.3V	USB_POWEREN1#	USB Front Panel Right Port Power Enable
GPIO 25-26	I	3.3V	N/A	Not used on SC1 (pulled via resistor to +3.3V)
GPIO 27	O	3.3V	USB_POWEREN2#	USB Front Panel Left Port Power Enable
GPIO 28	O	3.3V	SPM_MODE1	JMB393 RAID Controller: Configuration MODE1
GPIO 29	O	3.3V	N/A	Fixed to chipset internal function
GPIO 30-32	I	3.3V	N/A	Fixed to chipset internal function
GPIO 33	O	3.3V	N/A	Not used on SC1

GPIO Usage QM77 PCH				
GPIO	Type	Tol.	Function	Description
GPIO 34	O	3.3V	EXP_SMB_EN	Connect SMBus on J-EXP to local SMBus LOW: J-EXP disconnected from SMBus HIGH: J-EXP connected to SMBus
GPIO 35	I	3.3V	CPCI_SMB_EN	Connect SMBus on CPCI Serial to local SMBus LOW: CPCI Backplane disconnected from SMBus HIGH: CPCI Backplane connected to SMBus
GPIO36-37	I	3.3V	N/A	Not used on SC1 (pulled via resistor to GND)
GPIO 38	O	3.3V	SGPIO_LOAD	Serial GPIO Bus LOAD (P1 K3: SATA_SL)
GPIO 39	O	3.3V	SGPIO_OUT	Serial GPIO Bus DATAOUT (P1 H3: SATA_SDO)
GPIO 40	I	3.3V	USB_OC1#	USB Front Panel Right Port Overcurrent Detect
GPIO 41	O	3.3V	ENABLE_NC3	Enable Ethernet Controller NC3
GPIO 42	O	3.3V	ENABLE_NC4	Enable Ethernet Controller NC4
GPIO 43	I	3.3V	USB_OC4#	USB J-HSE Port 1 Overcurrent Detect
GPIO 44-47	I	3.3V	N/A	Not used on SC1 (pulled via resistor to +3.3V)
GPIO 48-49	I	3.3V	N/A	Not used on SC1 (pulled via resistor to GND)
GPIO 50	I	5V	N/A	Not used on SC1 (pulled via resistor to +3.3V)
GPIO 51	O	3.3V	N/A	Not used on SC1 (pulled via resistor to +3.3V)
GPIO 52	I	5V	N/A	Not used on SC1 (pulled via resistor to +3.3V)
GPIO 53	O	3.3V	N/A	Not used on SC1
GPIO 54	I	5V	N/A	Not used on SC1 (pulled via resistor to +3.3V)
GPIO 55	O	3.3V	ENABLE_NC2	Enable Ethernet Controller NC2
GPIO 56	I	3.3V	N/A	Not used on SC1 (pulled via resistor to +3.3V)
GPIO 57	O	3.3V	SPM_MODE2	JMB393 RAID Controller: Set Configuration <sup>1)</sup>
GPIO 58	I	3.3V	N/A	Not used on SC1 (pulled via resistor to +3.3V)
GPIO 59	I	3.3V	USB_OC0#	USB Front Panel Right Port Overcurrent Detect
GPIO 60	I	3.3V	N/A	Not used on SC1 (pulled via resistor to +3.3V)
GPIO 61-62	O	3.3V	N/A	Not used on SC1
GPIO 63	O	3.3V	N/A	Multiplexed with chipset internal function
GPIO 64-67	I	3.3V	BOARD_CFG	Board Configuration Jumpers
GPIO68-71	I	N/A	N/A	Not implemented in PCH QM57
GPIO 72	I	3.3V	N/A	Not used on SC1 (pulled via resistor to +3.3V)
GPIO 73	I	3.3V	N/A	Not used on SC1
GPIO 74-75	I	3.3V	N/A	Not used on SC1 (pulled via resistor to +3.3V)

<sup>1)</sup> GPIOs 8 and 57 have been swapped in Rev. 1 of SC1. Shown is the assignment as in Rev. 1.

## Configuration Jumpers

### Configuration PCI Express Switch (DS-P)

The link width and transfer rate of the PCI Express interfaces attached to the local expansion connector P-PCIE is configurable by two DIP switches (DS-P) located on the backside of the SC1-ALLEGRO. Note that changes in PCIe link configuration are honoured by the SC1-ALLEGRO not before a system reset was performed.



DS-P

DS-P		PCIe Link Width		
1	2	PCIe Switch Upstream	CPCI Serial <sup>1)</sup>	J-PCIE
OFF	OFF	4 Lanes @ 5GT/s	4 Links x 1 Lane @ 5GT/s	4 Links x 1 Lane @ 5GT/s
ON	OFF	4 Lanes @ 5GT/s	4 Links x 1 Lane @ 5GT/s	1 Link x 4 Lanes @ 5GT/s
OFF	ON	4 Lanes @ 2.5GT/s	4 Links x 1 Lane @ 2.5GT/s	4 Links x 1 Lane @ 2.5GT/s
ON	ON	4 Lanes @ 2.5GT/s	4 Links x 1 Lane @ 2.5GT/s	1 Link x 4 Lanes @ 2.5GT/s

<sup>1)</sup> Consists to the non fat pipe slots, generally periphery slots 3 to 6.

When the port on J-PCIE is configured as single link, the PCIe switch may size down the link width to x2 or x1 by auto-negotiation.

The following table shows the factory settings of DS-P with different side boards mounted to the SC1-ALLEGRO:

Side Board	DS-P		PCIe Link Width
	1	2	J-PCIE
None	OFF	OFF	4 Links x 1 Lane @ 5GT/s
CCI-RAP	OFF	OFF	4 Links x 1 Lane @ 5GT/s
CCK-MARIMBA	ON	OFF	1 Link x 4 Lanes @ 5GT/s
CCL-CAPELLA	ON	OFF	1 Link x 4 Lanes @ 5GT/s
CCO-CONCERT	OFF	ON	4 Links x 1 Lane @ 2.5GT/s
PCS-BALLET	OFF	OFF	4 Links x 1 Lane @ 5GT/s

## Loading UEFI BIOS Setup Defaults (P-GP)

The jumper P-GP may be used to reset the UEFI BIOS configuration settings to a default state. The UEFI BIOS on SC1-ALLEGRO stores most of its settings in an area within the BIOS flash, e.g. the actual boot devices. Using the jumper P-GP is only necessary, if it is not possible to enter the setup of the BIOS. To reset the settings mount a jumper on P-GP and perform a system reset. As long as the jumper is stuffed the BIOS will use the default configuration values after any system reset. To get normal operation again, the jumper has to be removed.



P-GP	Function
Jumper Removed <sup>1)</sup>	Normal operation
Jumper Installed	BIOS configuration reset performed

<sup>1)</sup> This setting is the factory default

## Manufacturer Mode Jumper (P-MFG)

The jumper P-MFG is used to bring the board into the manufacturer mode. This is necessary only on board production time and should not be used by customers. For normal operation the jumper should be removed. The pin header P-MFG is not stuffed on the SC1-ALLEGRO by default.



P-MFG	Function
Jumper Removed <sup>1)</sup>	Normal operation
Jumper Installed	Entering Manufacturer Mode

<sup>1)</sup> This setting is the factory default

## RTC Reset (P-RTC)

The jumper P-RTC may be used to reset certain register bits of the battery backed RTC core within the PCH QM77. This can be necessary under rare conditions (e.g. battery undervoltage), if the CPU fails to enter the BIOS POST after power on. Note that installing of jumper P-RTC will neither set UEFI BIOS Setup to EKF Factory Defaults nor resets the time and date register values of the RTC (Real Time Clock). To reset the RTC core the board must be removed from the system rack. Short-circuit the pins of P-RTC for about 1 sec. Thereafter reinstall the board to the system and switch on the power. It is important to accomplish the RTC reset while the board has no power. The pin header P-RTC is not stuffed on the SC1-ALLEGRO by default.



P-RTC

P-RTC	Function
Jumper Removed <sup>1)</sup>	Normal operation
Jumper Installed	RTC reset performed

<sup>1)</sup> This setting is the factory default.



## Connectors

### Caution

Some of the internal connectors provide operating voltage (3.3V and 5V) to devices inside the system chassis, such as internal peripherals. Not all of these connectors are short circuit protected. Do not use these internal connectors for powering devices external to the computer chassis. A fault in the load presented by the external devices could cause damage to the board, the interconnecting cable and the external devices themselves.

### Front Panel Connectors

With respect to the video connector, the SC1-ALLEGRO is available in two flavours, either dual mDP or VGA.

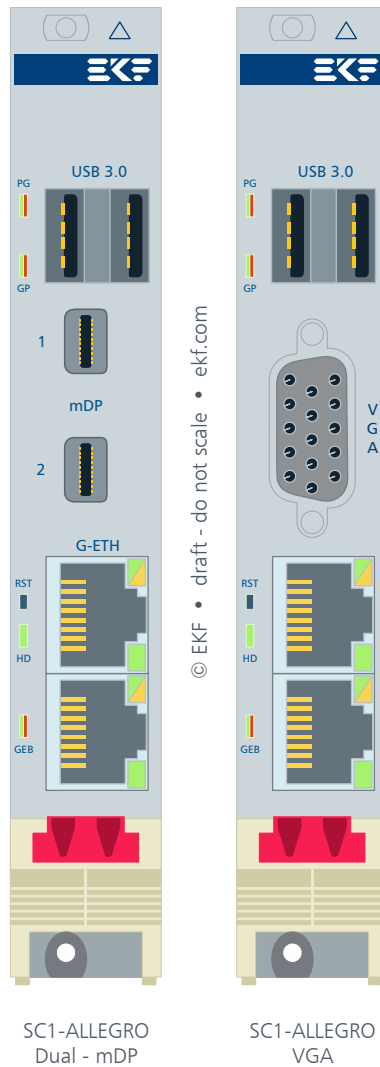

## DisplayPort Connectors

The Intel® i7 processors used on SC1-ALLEGRO are equipped with an integrated graphics controller, which supports DisplayPort and SDVO interfaces permitting simultaneous independent operation of up to three displays. Two DP receptacles are available from the SC1-ALLEGRO front panel, as mDP (Mini DisplayPort) connectors, which is a space saving alternate to the standard DP connector and is also specified by the VESA.

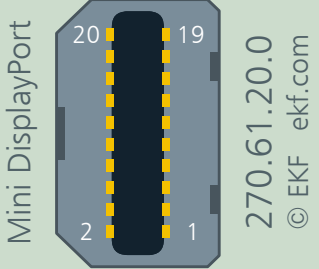
Mini DisplayPort J-DP1/2				
	20	PWR <sup>1)</sup>	19	GND
	18	AUX_CH(N)	17	LANE2(N)
	16	AUX_CH(P)	15	LANE2(P)
	14	GND	13	GND
	12	LANE3(N)	11	LANE1(N)
	10	LANE3(P)	9	LANE1(P)
	8	GND	7	GND
	6	CONFIG2 (GND)	5	LANE0(N)
	4	CONFIG1	3	LANE0(P)
	2	Hot Plug Detect	1	GND

<sup>1)</sup> +3.3V protected by a self resetting PolySwitch fuse 0.75A. This voltage is switched on in S0 state only.

Most DisplayPort monitors come with the standard DP connector, hence requiring a mDP to DP cable assembly for use with the SC1-ALLEGRO. For attachment of either a classic style analog RGB monitor, DVI or HDMI type display to the J-DP receptacles, there are both adapters and also adapter cables available.

Specified by the VESA DisplayPort connector standard is a dedicated power pin 20 (+3.3V 0.5A). Both the GPU (source side) and a DP monitor (sink side) must provide power via this pin. A VESA specified standard DisplayPort cable however **must not connect** the **pins 20** of both cable ends, in order to avoid a back driving conflict. Unfortunately there are cable assemblies available with pin 20 passed through, with unpredictable results on the system behaviour. Before ordering DP cable assemblies, verify the associated wiring diagram.

Sample VESA Compliant Mini DisplayPort Cable Assemblies	
2.0m Mini DisplayPort (mDP) to DisplayPort (DP) plug to plug cable assembly, VESA compliant EKF Part. #270.66.2.02.0	
Astron	T2M2M20020-R
Molex	0687850003
Roline	1045636
Wieson	G9858

A third DisplayPort video output is available when combining the SC1-ALLEGRO with the mezzanine side cards SCS-TRUMPET or PCS-BALLET. The standard DP connector is provided with latches, which may be preferred for some applications.



SC1-ALLEGRO w. PCS-BALLET C32-FIO (12HP)



SC1-ALLEGRO w. SCS-TRUMPET Side Card 8HP Assembly



## VGA Video Connector

As an option, the SC1-ALLEGRO can be equipped with a legacy VGA connector (High-Density D-Sub 15-position female connector). The connector VGA replaces the two Mini DisplayPort receptacles, and the digital video interface therefore is not available concurrently with this option.

J-VGA (Option)		
	1	RED
	2	GREEN
	3	BLUE
	4	NC
	5	GND
	6	GND
	7	GND
	8	GND
	9	DDC_POW <sup>1)</sup>
	10	GND
	11	NC
	12	VGA_DDC_SDA
	13	HSYNC
	14	VSYNC
	15	VGA_DDC_SCL

<sup>1)</sup> +3.3V protected by a self resetting PolySwitch fuse 0.75A. This voltage is switched on in S0 state only.

## USB Connectors

The Intel® QM77 Platform Controller Hub incorporates a four-port USB 3.0 xHCI host controller. Two ports are directly available on the SC1-ALLEGRO front panel (type A receptacle), for attachment of external USB devices.

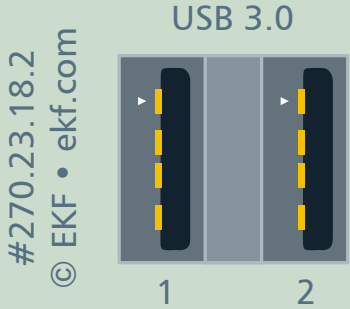
USB • Dual USB 3.0 Receptacle USB 3.0 dual type A receptacle, stacked, 18-position		
	1	VBUS +5V, 1.5A max <sup>1)</sup>
	2	USB D-
	3	USB D+
	4	GND
	5	SS RX-
	6	SS RX+
	7	GND
	8	SS TX-
	9	SS TX+

<sup>1)</sup> +5V via 1.5A current-limited electronic power switch. Power rail may be switched off by software independently for each port.

Another two USB 3.0 connectors would be available when the SC1-ALLEGRO is combined with the PCS-BALLET mezzanine side card.



SC1-ALLEGRO w. PCS-BALLET Mezzanine Side Card (8HP)

## Ethernet Connectors

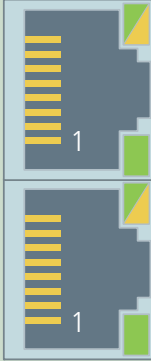
Gigabit Ethernet Ports 1/2 (J-ETH, RJ-45)			
 <p>270.02.08.5</p>	Port 1	1	NC1_MDX0+
		2	NC1_MDX0-
		3	NC1_MDX1+
		4	NC1_MDX2+
		5	NC1_MDX2-
		6	NC1_MDX1-
		7	NC1_MDX3+
		8	NC1_MDX3-
	Port 2	1	NC2_MDX0+
		2	NC2_MDX0-
		3	NC2_MDX1+
		4	NC2_MDX2+
		5	NC2_MDX2-
		6	NC2_MDX1-
		7	NC2_MDX3+
		8	NC2_MDX3-

The lower green LED indicates LINK established when continuously on, and data transfer (activity) when blinking. If the lower green LED is permanently off, no LINK is established. The upper green/yellow dual-LED signals the link speed 1Gbit/s when lit yellow, 100Mbit/s when lit green, and 10Mbit/s when off.

## Mezzanine Connectors



Mezzanine Side Card Connector Suite

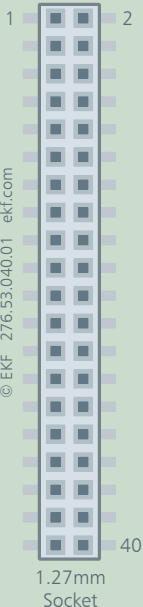

## Expansion Interface J-EXP

J-EXPT (J-EXPB optional)				
	GND	1	2	+3.3V <sup>1)</sup>
	PCI_CLK (33MHz)	3	4	RST_PLC#
	LPC_AD0	5	6	LPC_AD1
	LPC_AD2	7	8	LPC_AD3
	LPC_FRM#	9	10	LPC_DRQ#
	GND	11	12	+3.3V <sup>1)</sup>
	LPC_SERIRQ	13	14	WAKE#
	EXP_SMI#	15	16	SIO_CLK (14.3MHz)
	FWH_ID0	17	18	FWH_INIT#
	KBRST#	19	20	A20GATE
	GND	21	22	+5V <sup>1)</sup>
	USB_EXP2-	23	24	USB_EXP1-
	USB_EXP2+	25	26	USB_EXP1+
	USB_EXP_OC#	27	28	DBRESET#
	EXP_SCL <sup>2)</sup>	29	30	EXP_SDA <sup>2)</sup>
	GND	31	32	+5V <sup>1)</sup>
	HDA_SDOUT	33	34	HDA_SDIN0
	HDA_RST#CL_RST# <sup>3)</sup>	35	36	HDA_SYNC
	HDA_CLK/CL_CLK <sup>3)</sup>	37	38	HDA_SDIN1/CL_DATA <sup>3)</sup>
	SPEAKER	39	40	+12V <sup>4)</sup>

- 1) Power rail switched on in state S0 only.
- 2) Connected to SMBus via buffered switch, isolated after reset.
- 3) Stuffing option, default is the HDA option.
- 4) Power rail switch off in state S5.

The expansion interface header footprint is available on both sides of the board, top (J-EXPT) and bottom (J-EXPB). The bottom side connector is stuffed only on customers request.

**WARNING:** The +3.3V/+5V/+12V power pins are not protected against a short circuit event. The connector J-EXP therefore should be used only for attachment of an approved expansion side card. The maximum current flow across these pins should be limited to 1A per power pin.

## High Speed Expansion Connector J-HSE

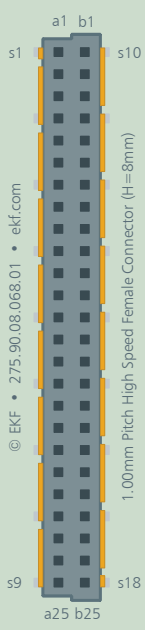
High Speed Expansion J-HSE				
 <p>© EKF • 275.90.08.068.01 • ekf.com</p> <p>1.00mm Pitch High Speed Female Connector (H=8mm)</p>	GND	a1	b1	GND
	SATA_HSE1_TXP <sup>5)</sup>	a2	b2	SATA_HSE3_TXP <sup>4) 5)</sup>
	SATA_HSE1_TXN <sup>5)</sup>	a3	b3	SATA_HSE3_TXN <sup>4) 5)</sup>
	GND	a4	b4	GND
	SATA_HSE1_RXN <sup>5)</sup>	a5	b5	SATA_HSE3_RXN <sup>4) 5)</sup>
	SATA_HSE1_RXP <sup>5)</sup>	a6	b6	SATA_HSE3_RXP <sup>4) 5)</sup>
	GND	a7	b7	GND
	SATA_HSE2_TXP <sup>4) 5)</sup>	a8	b8	SATA_HSE4_TXP <sup>5) 6)</sup>
	SATA_HSE2_TXN <sup>4) 5)</sup>	a9	b9	SATA_HSE4_TXN <sup>5) 6)</sup>
	GND	a10	b10	GND
	SATA_HSE2_RXN <sup>4) 5)</sup>	a11	b11	SATA_HSE4_RXN <sup>5) 6)</sup>
	SATA_HSE2_RXP <sup>4) 5)</sup>	a12	b12	SATA_HSE4_RXP <sup>5) 6)</sup>
	GND	a13	b13	GND
	USB_HSE1_P	a14	b14	USB_HSE3_P
	USB_HSE1_N	a15	b15	USB_HSE3_N
	GND	a16	b16	GND
	USB_HSE2_P	a17	b17	USB_HSE4_P
	USB_HSE2_N	a18	b18	USB_HSE4_N
	GND	a19	b19	GND
	USB_HSE_OC1#	a20	b20	USB_HSE_OC34#
	USB_HSE_OC2#	a21	b21	USB_HSE_OC34#
	+3.3VS <sup>1)</sup>	a22	b22	+5VS <sup>1)</sup>
	+3.3VS <sup>1)</sup>	a23	b23	+5VS <sup>1)</sup>
	+3.3VA <sup>2)</sup>	a24	b24	+5VA <sup>2)</sup>
	+12V <sup>3)</sup>	a25	b25	+12V <sup>3)</sup>

- <sup>1)</sup> Power rail switched on in state S0 only (Switched).
- <sup>2)</sup> Power rail on with system stand-by power (Always).
- <sup>3)</sup> Power rail switch off in state S5.
- <sup>4)</sup> This SATA channel is capable to perform up to 6Gbps.
- <sup>5)</sup> All TX/RX designations with respect to the SATA controller.
- <sup>6)</sup> This SATA channel was moved to the CompactPCI Serial Backplane with Rev.2 of SC1-ALLEGRO.

**WARNING:** The +3.3V/+5V/+12V power pins are not protected against a short circuit event. The connector J-HSE therefore should be used only for attachment of an approved expansion side card. The maximum current flow through these power pins should be limited to 0.5A per pin.

## PCI Express® Expansion Header J-PCIE

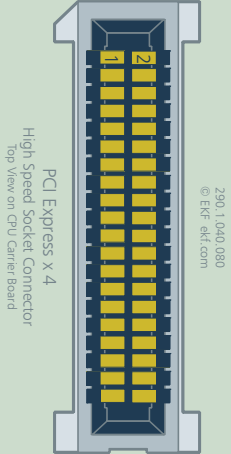
J-PCIE				
	GND	1	2	GND
	+5V <sup>1)</sup>	3	4	+3.3V <sup>1)</sup>
	+5V <sup>1)</sup>	5	6	+3.3V <sup>1)</sup>
	GND	7	8	GND
	PE_CLKP	9	10	PLTRST#
	PE_CLKN	11	12	PE_WAKE#
	GND	13	14	GND
	PE_1TP	15	16	PE_1RP
	PE_1TN	17	18	PE_1RN
	GND	19	20	GND
	GND	21	22	GND
	PE_2TP	23	24	PE_2RP
	PE_2TN	25	26	PE_2RN
	GND	27	28	GND
	PE_3TP	29	30	PE_3RP
	PE_3TN	31	32	PE_3RN
	GND	33	34	GND
	PE_4TP	35	36	PE_4RP
	PE_4TN	37	38	PE_4RN
	GND	39	40	GND

<sup>1)</sup> Power rail switched on in state S0 only.

**WARNING:** The +3.3V/+5V power pins are not protected against a short circuit event. The connector J-PCIE therefore should be used only for attachment of an approved expansion side card. The maximum current flow through these power pins should be limited to 1A per pin.

## SDVO/DisplayPort Expansion Header J-SDVO

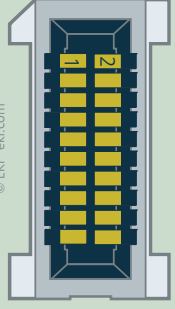
J-SDVO				
	GND	1	2	GND
	SDVO_RED+/DP_LANE0+	3	4	SDVO_CLK+/DP_LANE3+
	SDVO_RED-/DP_LANE0-	5	6	SDVO_CLK-/DP_LANE3-
	GND	7	8	GND
	SDVO_GREEN+/DP_LANE1+	9	10	SDVO_INT+/DP_AUX+
	SDVO_GREEN-/DP_LANE1-	11	12	SDVO_INT-/DP_AUX-
	GND	13	14	GND
	SDVO_BLUE+/DP_LANE2+	15	16	SDVO_CTR_CLK/DP_HPD
	SDVO_BLUE-/DP_LANE2-	17	18	SDVO_CTR_DATA/DP_CFG1
	GND	19	20	GND

To use J-SDVO as either an SDVO or a further DisplayPort interface, some of the control lines are configurable by a multiplexer. The state of this multiplexer is controlled by PCH QM77 GPIO16 and adjustable by BIOS.

Setting GPIO16 to LO configures the connector J-SDVO to work in SDVO mode. In this case pins 10/12 carry the SDVO\_INT and pins 16/18 the SDVO\_CTR function.

With GPIO16 set to HIGH the connector behaves like a DisplayPort interface. The pins 10/12 function as DP\_AUX while pin 16 and 18 are connected to DP\_HPD and DP\_CFG1 respectively.



SC1-ALLEGRO w. PCS-BALLET & Half-Slim SATA SSD (8HP)



SC1-ALLEGRO w. PCS-BALLET & C41-CFAST (8HP)



Typical 8HP Assembly w. PCS-BALLET Side Card & C42-SATA



8HP Assembly w. PCS-BALLET Side Card & C47-MSATA

## Pin Headers & Debug

### Front Panel Handle Microswitch Header P-FPH

The jumper P-FPH is used for attachment of an external SPDT switch. By default, P-FPH is connected across a short cable harness to a microswitch, which is integrated into the SC1-ALLEGRO front panel handle (ejector lever). The switch performs a power button event (e.g. system shutdown) by short-circuiting the pins 1 and 3 of P-FPH when activated (hold unlock button of front panel handle depressed momentarily).

P-FPH		
# 276.02.003.11 © EKF • ekf.com		
		
1	black	Microswitch Pole (Common), Wired to PLD
2	red	Microswitch Throw - F/P Handle Locked Position, NC
3	yellow	Microswitch Throw - F/P Handle Unlocked Position, Wired to GND

### PLD Programming Header P-ISP

The SC1-ALLEGRO is provided with a powerful PLD (in-System Programmable Logic Device) which replaces legacy glue logic. The programming header P-ISP is not stuffed (in use for manufacturing only). Its footprint is situated at the bottom side of the board.

P-ISP	
240.1.08.1 • © EKF • ekf.com	
	
1	+3.3V
2	TDO
3	TDI
4	NC
5	KEY
6	TMS
7	GND
8	TCK

## Processor Debug Header XDP1

The SC1-ALLEGRO may be equipped with a 26-position processor debug header for hard- and software debugging (specified by Intel<sup>®</sup> as XDP-SFF-26 Pin Platform Connection). The connector is suitable for installation of a flat flex cable (FFC), in order to attach an JTAG debugger (emulator) such as the Arium ECM-XDP3. An adapter (ITP-XDP-SFF-26) is required in addition to convert the 26-pin XDP-SFF-26 Pin connector to the standard 60-pin XDP.

The header XDP1 would be mounted on the PCB bottom side, but is not stuffed by default.

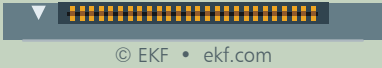
XDP Processor Debug Connector			
269.1.026.902 • FFC Connector			
			
© EKF • ekf.com			
1	OBSFN_A0 (PREQ#)	OBSFN_A1 (PRDY#)	2
3	GND	<i>OBSDATA_A0</i>	4
5	<i>OBSDATA_A1</i>	GND	6
7	<i>OBSDATA_A2</i>	<i>OBSDATA_A3</i>	8
9	GND	HOOK0 (CPU_PWRGOOD)	10
11	HOOK1 (XDP_PWRBTN)	HOOK2 (CFG[0])	12
13	HOOK3 (SYS_PWROK)	HOOK4 (BCLKP)	14
15	HOOK5 (BCLKN)	VCCOBS_AB (+1.05V)	16
17	HOOK6 (PLTRST#)	HOOK7 (DBRESET#)	18
19	GND	TDO	20
21	TRST#	TDI	22
23	TMS	<i>TCK1</i>	24
25	GND	TCK0 (TCK)	26



## Backplane Connectors

Six high speed backplane connectors optimized for differential signal transmission are specified as P1 to P6 by the PICMG<sup>®</sup> *CompactPCI*<sup>®</sup> Serial. The mandatory P1 conveys amongst others the power, system control and status pins.

## CompactPCI® Serial Backplane Connector P1

P1 CompactPCI® Serial System Slot Backplane Connector • EKF Part #250.3.1206.20.02 72 pos. 12x6, 14mm Width, Type A												
P1	A	B	C	D	E	F	G	H	I	J	K	L
6	GND	1_PE_TX02+	1_PE_TX02-	GND	1_PE_RX02+	1_PE_RX02-	GND	1_PE_TX03+	1_PE_TX03-	GND	1_PE_RX03+	1_PE_RX03-
5	1_PE_TX00+	1_PE_TX00-	GND	1_PE_RX00+	1_PE_RX00-	GND	1_PE_TX01+	1_PE_TX01-	GND	1_PE_RX01+	1_PE_RX01-	GND
4	GND	1_USB2+	1_USB2-	GND	reserved <sup>1)</sup>	reserved <sup>1)</sup>	GND	1_SATA_TX+ <sup>2)</sup>	1_SATA_TX- <sup>2)</sup>	GND	1_SATA_RX+ <sup>2)</sup>	1_SATA_RX- <sup>2)</sup>
3	1_USB3_TX+	1_USB3_TX-	PWRBTN#	1_USB3_RX+	1_USB3_RX-	PWR_FAIL#	SATA_SDI <sup>1)3)</sup>	SATA_SDO <sup>3)</sup>	GA2 <sup>1)</sup>	SATA_SCL <sup>3)</sup>	SATA_SL <sup>3)</sup>	GA3 <sup>1)</sup>
2	GND	I <sup>2</sup> C_SCL	I <sup>2</sup> C_SDA	GND	PS_ON#	RST#	GND	PRST#	WAKE_IN#	GND	reserved <sup>1)</sup>	SYSEN#
1	+12V	+5V STANDBY	GND	+12V	+12V	GND	+12V	+12V	GND	+12V	+12V	GND

<sup>1)</sup> Not connected.

<sup>2)</sup> Not connected (according the CompactPCI® Serial Precedence Order Rules).

<sup>3)</sup> 10kΩ Pull-Up resistor to +3.3V when board is inserted in system controller slot.

## CompactPCI® Serial Backplane Connector P2

P2 CompactPCI® Serial System Slot Backplane Connector • EKF Part #250.3.1208.20.00 96 pos. 12x8, 16mm Width, Type B												
P2	A	B	C	D	E	F	G	H	I	J	K	L
8	GND	IO <sup>1)</sup>	IO <sup>1)</sup>	GND	2_USB2+	2_USB2-	GND	3_USB2+	3_USB2-	IO <sup>1)</sup>	4_USB2+	4_USB2-
7	IO <sup>1)</sup>	IO <sup>1)</sup>	GND	IO <sup>1)</sup>	IO <sup>1)</sup>	GND	IO <sup>1)</sup>	IO <sup>1)</sup>	GND	IO <sup>1)</sup>	IO <sup>1)</sup>	GND
6	GND	2_PE_TX06+	2_PE_TX06-	GND	2_PE_RX06+	2_PE_RX06-	GND	2_PE_TX07+	2_PE_TX07-	GND	2_PE_RX07+	2_PE_RX07-
5	2_PE_TX04+ <sup>3)</sup>	2_PE_TX04- <sup>3)</sup>	GND	2_PE_RX04+	2_PE_RX04-	GND	2_PE_TX05+	2_PE_TX05-	GND	2_PE_RX05+	2_PE_RX05-	GND
4	GND	2_PE_TX02+	2_PE_TX02-	GND	2_PE_RX02+	2_PE_RX02-	GND	2_PE_TX03+	2_PE_TX03-	GND	2_PE_RX03+	2_PE_RX03-
3	2_PE_TX00+	2_PE_TX00-	GND	2_PE_RX00+	2_PE_RX00-	GND	2_PE_TX01+ <sup>3)</sup>	2_PE_TX01- <sup>3)</sup>	GND	2_PE_RX01+	2_PE_RX01-	GND
2	GND	1_PE_TX06+	1_PE_TX06-	GND	1_PE_RX06+	1_PE_RX06-	GND	1_PE_TX07+	1_PE_TX07-	GND	1_PE_RX07+	1_PE_RX07-
1	1_PE_TX04+ <sup>3)</sup>	1_PE_TX04- <sup>3)</sup>	GND	1_PE_RX04+	1_PE_RX04-	GND	1_PE_TX05+	1_PE_TX05-	GND	1_PE_RX05+	1_PE_RX05-	GND

<sup>1)</sup> Not connected.

<sup>2)</sup> The PCI Express Lanes 1\_PE\_\* and 2\_PE\_\* are derived from the i7 processor and capable to transfer 8GT/s.

<sup>3)</sup> Polarity inversion was made on these lanes on SC1-ALLEGRO for better routing. This is allowed according the "PCI Express Base Specification 3.0" and has no effect on function or performance of the link. The pin-out shown is as per specification.

## CompactPCI® Serial Backplane Connector P3

P3 CompactPCI® Serial System Slot Backplane Connector • EKF Part #250.3.1208.20.00 96 pos. 12x8, 16mm Width, Type B												
P3	A	B	C	D	E	F	G	H	I	J	K	L
8	GND	7_SATA_TX+ <sub>2) 3)</sub>	7_SATA_TX- <sub>2) 3)</sub>	GND	7_SATA_RX+ <sub>2) 3)</sub>	7_SATA_RX- <sub>2) 3)</sub>	GND	8_SATA_TX+ <sub>2) 3)4)</sub>	8_SATA_TX- <sub>2) 3)4)</sub>	GND	8_SATA_RX+ <sub>2) 3)4)</sub>	8_SATA_RX- <sub>2) 3)4)</sub>
7	5_SATA_TX+	5_SATA_TX-	GND	5_SATA_RX+	5_SATA_RX-	GND	6_SATA_TX+	6_SATA_TX-	GND	6_SATA_RX+	6_SATA_RX-	GND
6	GND	3_SATA_TX+ <sub>5)</sub>	3_SATA_TX- <sub>5)</sub>	GND	3_SATA_RX+ <sub>5)</sub>	3_SATA_RX- <sub>5)</sub>	GND	4_SATA_TX+	4_SATA_TX-	GND	4_SATA_RX+	4_SATA_RX-
5	8_USB3_TX+ <sub>1)</sub>	8_USB3_TX- <sub>1)</sub>	GND	8_USB3_RX+ <sub>1)</sub>	8_USB3_RX- <sub>1)</sub>	GND	2_SATA_TX+ <sub>6)</sub>	2_SATA_TX- <sub>6)</sub>	GND	2_SATA_RX+ <sub>6)</sub>	2_SATA_RX- <sub>6)</sub>	GND
4	GND	6_USB3_TX+ <sub>1)</sub>	6_USB3_TX- <sub>1)</sub>	GND	6_USB3_RX+ <sub>1)</sub>	6_USB3_RX- <sub>1)</sub>	GND	7_USB3_TX+ <sub>1)</sub>	7_USB3_TX- <sub>1)</sub>	GND	7_USB3_RX+ <sub>1)</sub>	7_USB3_RX- <sub>1)</sub>
3	4_USB3_TX+ <sub>1)</sub>	4_USB3_TX- <sub>1)</sub>	GND	4_USB3_RX+ <sub>1)</sub>	4_USB3_RX- <sub>1)</sub>	GND	5_USB3_TX+ <sub>1)</sub>	5_USB3_TX- <sub>1)</sub>	GND	5_USB3_RX+ <sub>1)</sub>	5_USB3_RX- <sub>1)</sub>	GND
2	GND	2_USB3_TX+	2_USB3_TX-	GND	2_USB3_RX+	2_USB3_RX-	GND	3_USB3_TX+ <sub>1)</sub>	3_USB3_TX- <sub>1)</sub>	GND	3_USB3_RX+ <sub>1)</sub>	3_USB3_RX- <sub>1)</sub>
1	5_USB2+	5_USB2-	GND	6_USB2+	6_USB2-	GND	7_USB2+ <sub>1)</sub>	7_USB2- <sub>1)</sub>	GND	8_USB2+ <sub>1)</sub>	8_USB2- <sub>1)</sub>	GND

<sup>1)</sup> Not connected (according to the CompactPCI® Serial Precedence Order Rules).

<sup>2)</sup> This SATA channel is derived from the PCH QM77. The remaining SATA channels are derived from the JMB393 RAID Controller.

<sup>3)</sup> This SATA channel was derived from the JMB393 RAID Controller in Rev. 1 of SC1-ALLEGRO.

<sup>4)</sup> This SATA channel was connected to J-HSE SATA Port 4 in Rev.1 of SC1-ALLEGRO.

<sup>5)</sup> This SATA channel was derived from the PCH QM77 in Rev. 1 of SC1-ALLEGRO.

<sup>6)</sup> This SATA channel derived from the JMB393 RAID Controller was not connected in Rev. 1 of SC1-ALLEGRO.

## CompactPCI® Serial Backplane Connector P4

P4 CompactPCI® Serial System Slot Backplane Connector • EKF Part #250.3.1208.20.00 96 pos. 12x8, 16mm Width, Type B												
P4	A	B	C	D	E	F	G	H	I	J	K	L
8	GND	6_PE_TX02+ <sub>1)</sub>	6_PE_TX02- <sub>1)</sub>	GND	6_PE_RX02+ <sub>1)</sub>	6_PE_RX02- <sub>1)</sub>	GND	6_PE_TX03+ <sub>1)</sub>	6_PE_TX03- <sub>1)</sub>	GND	6_PE_RX03+ <sub>1)</sub>	6_PE_RX03- <sub>1)</sub>
7	6_PE_TX00+	6_PE_TX00-	GND	6_PE_RX00+	6_PE_RX00-	GND	6_PE_TX01+ <sub>1)</sub>	6_PE_TX01- <sub>1)</sub>	GND	6_PE_RX01+ <sub>1)</sub>	6_PE_RX01- <sub>1)</sub>	GND
6	GND	5_PE_TX02+ <sub>1)</sub>	5_PE_TX02- <sub>1)</sub>	GND	5_PE_RX02+ <sub>1)</sub>	5_PE_RX02- <sub>1)</sub>	GND	5_PE_TX03+ <sub>1)</sub>	5_PE_TX03- <sub>1)</sub>	GND	5_PE_RX03+ <sub>1)</sub>	5_PE_RX03- <sub>1)</sub>
5	5_PE_TX00+	5_PE_TX00-	GND	5_PE_RX00+	5_PE_RX00-	GND	5_PE_TX01+ <sub>1)</sub>	5_PE_TX01- <sub>1)</sub>	GND	5_PE_RX01+ <sub>1)</sub>	5_PE_RX01- <sub>1)</sub>	GND
4	GND	4_PE_TX02+ <sub>1)</sub>	4_PE_TX02- <sub>1)</sub>	GND	4_PE_RX02+ <sub>1)</sub>	4_PE_RX02- <sub>1)</sub>	GND	4_PE_TX03+ <sub>1)</sub>	4_PE_TX03- <sub>1)</sub>	GND	4_PE_RX03+ <sub>1)</sub>	4_PE_RX03- <sub>1)</sub>
3	4_PE_TX00+	4_PE_TX00-	GND	4_PE_RX00+	4_PE_RX00-	GND	4_PE_TX01+ <sub>1)</sub>	4_PE_TX01- <sub>1)</sub>	GND	4_PE_RX01+ <sub>1)</sub>	4_PE_RX01- <sub>1)</sub>	GND
2	GND	3_PE_TX02+ <sub>1)</sub>	3_PE_TX02- <sub>1)</sub>	GND	3_PE_RX02+ <sub>1)</sub>	3_PE_RX02- <sub>1)</sub>	GND	3_PE_TX03+ <sub>1)</sub>	3_PE_TX03- <sub>1)</sub>	GND	3_PE_RX03+ <sub>1)</sub>	3_PE_RX03- <sub>1)</sub>
1	3_PE_TX00+	3_PE_TX00-	GND	3_PE_RX00+	3_PE_RX00-	GND	3_PE_TX01+ <sub>1)</sub>	3_PE_TX01- <sub>1)</sub>	GND	3_PE_RX01+ <sub>1)</sub>	3_PE_RX01- <sub>1)</sub>	GND

<sup>1)</sup> Not connected.

## CompactPCI® Serial Backplane Connector P5

P5 CompactPCI® Serial System Slot Backplane Connector • EKF Part #250.3.1206.20.00 72 pos. 12x6, 12mm Width, Type C												
P5	A	B	C	D	E	F	G	H	I	J	K	L
6	5_PE_CLKE#	5_PE_CLK+	5_PE_CLK-	6_PE_CLKE#	6_PE_CLK+	6_PE_CLK-	7_PE_CLKE# 2)	7_PE_CLK+ 2)	7_PE_CLK- 2)	8_PE_CLKE# 2)	8_PE_CLK+ 2)	8_PE_CLK- 2)
5	1_PE_CLK+	1_PE_CLK-	1_PE_CLKE#	2_PE_CLK+	2_PE_CLK-	2_PE_CLKE#	3_PE_CLK+	3_PE_CLK-	3_PE_CLKE#	4_PE_CLK+	4_PE_CLK-	4_PE_CLKE#
4	GND	8_PE_TX02+ 1)	8_PE_TX02- 1)	GND	8_PE_RX02+ 1)	8_PE_RX02- 1)	GND	8_PE_TX03+ 1)	8_PE_TX03- 1)	GND	8_PE_RX03+ 1)	8_PE_RX03- 1)
3	8_PE_TX00+ 2)	8_PE_TX00- 2)	GND	8_PE_RX00+ 2)	8_PE_RX00- 2)	GND	8_PE_TX01+ 1)	8_PE_TX01- 1)	GND	8_PE_RX01+ 1)	8_PE_RX01- 1)	GND
2	GND	7_PE_TX02+ 1)	7_PE_TX02- 1)	GND	7_PE_RX02+ 1)	7_PE_RX02- 1)	GND	7_PE_TX03+ 1)	7_PE_TX03- 1)	GND	7_PE_RX03+ 1)	7_PE_RX03- 1)
1	7_PE_TX00+ 2)	7_PE_TX00- 2)	GND	7_PE_RX00+ 2)	7_PE_RX00- 2)	GND	7_PE_TX01+ 1)	7_PE_TX01- 1)	GND	7_PE_RX01+ 1)	7_PE_RX01- 1)	GND

1) Not connected.

2) Not connected (according the CompactPCI® Serial Precedence Order Rules).

## CompactPCI® Serial Backplane Connector P6

P6 CompactPCI® Serial System Slot Backplane Connector • EKF Part #250.3.1208.20.02 96 pos. 12x8, 18mm Width, Type D												
P6	A	B	C	D	E	F	G	H	I	J	K	L
8	GND	8_ETH_A+ <small>1)</small>	8_ETH_A- <small>1)</small>	GND	8_ETH_B+ <small>1)</small>	8_ETH_B- <small>1)</small>	GND	8_ETH_C+ <small>1)</small>	8_ETH_C- <small>1)</small>	GND	8_ETH_D+ <small>1)</small>	8_ETH_D- <small>1)</small>
7	7_ETH_A+ <small>1)</small>	7_ETH_A- <small>1)</small>	GND	7_ETH_B+ <small>1)</small>	7_ETH_B- <small>1)</small>	GND	7_ETH_C+ <small>1)</small>	7_ETH_C- <small>1)</small>	GND	7_ETH_D+ <small>1)</small>	7_ETH_D- <small>1)</small>	GND
6	GND	6_ETH_A+ <small>1)</small>	6_ETH_A- <small>1)</small>	GND	6_ETH_B+ <small>1)</small>	6_ETH_B- <small>1)</small>	GND	6_ETH_C+ <small>1)</small>	6_ETH_C- <small>1)</small>	GND	6_ETH_D+ <small>1)</small>	6_ETH_D- <small>1)</small>
5	5_ETH_A+ <small>1)</small>	5_ETH_A- <small>1)</small>	GND	5_ETH_B+ <small>1)</small>	5_ETH_B- <small>1)</small>	GND	5_ETH_C+ <small>1)</small>	5_ETH_C- <small>1)</small>	GND	5_ETH_D+ <small>1)</small>	5_ETH_D- <small>1)</small>	GND
4	GND	4_ETH_A+ <small>1)</small>	4_ETH_A- <small>1)</small>	GND	4_ETH_B+ <small>1)</small>	4_ETH_B- <small>1)</small>	GND	4_ETH_C+ <small>1)</small>	4_ETH_C- <small>1)</small>	GND	4_ETH_D+ <small>1)</small>	4_ETH_D- <small>1)</small>
3	3_ETH_A+ <small>1)</small>	3_ETH_A- <small>1)</small>	GND	3_ETH_B+ <small>1)</small>	3_ETH_B- <small>1)</small>	GND	3_ETH_C+ <small>1)</small>	3_ETH_C- <small>1)</small>	GND	3_ETH_D+ <small>1)</small>	3_ETH_D- <small>1)</small>	GND
2	GND	2_ETH_A+	2_ETH_A-	GND	2_ETH_B+	2_ETH_B-	GND	2_ETH_C+	2_ETH_C-	GND	2_ETH_D+	2_ETH_D-
1	1_ETH_A+	1_ETH_A-	GND	1_ETH_B+	1_ETH_B-	GND	1_ETH_C+	1_ETH_C-	GND	1_ETH_D+	1_ETH_D-	GND

<sup>1)</sup> Not connected (according the CompactPCI® Serial Precedence Order Rules).

## Appendix

### Mechanical Drawing

The following drawing shows the positions of mounting holes and expansion connectors on the SC1-ALLEGRO.



SC1-ALLEGRO • PCB Dimensions • © EKF • ekf.com





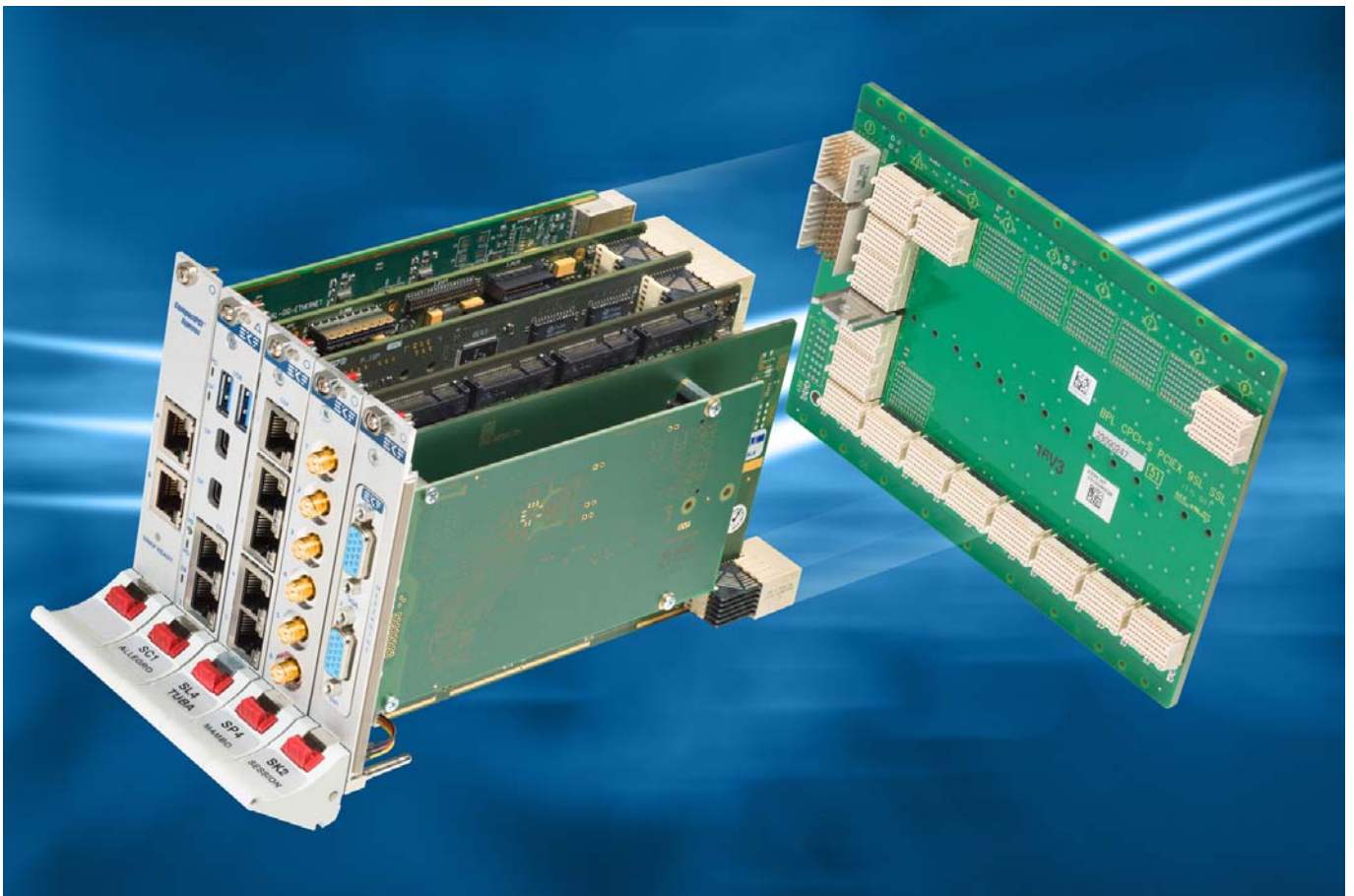
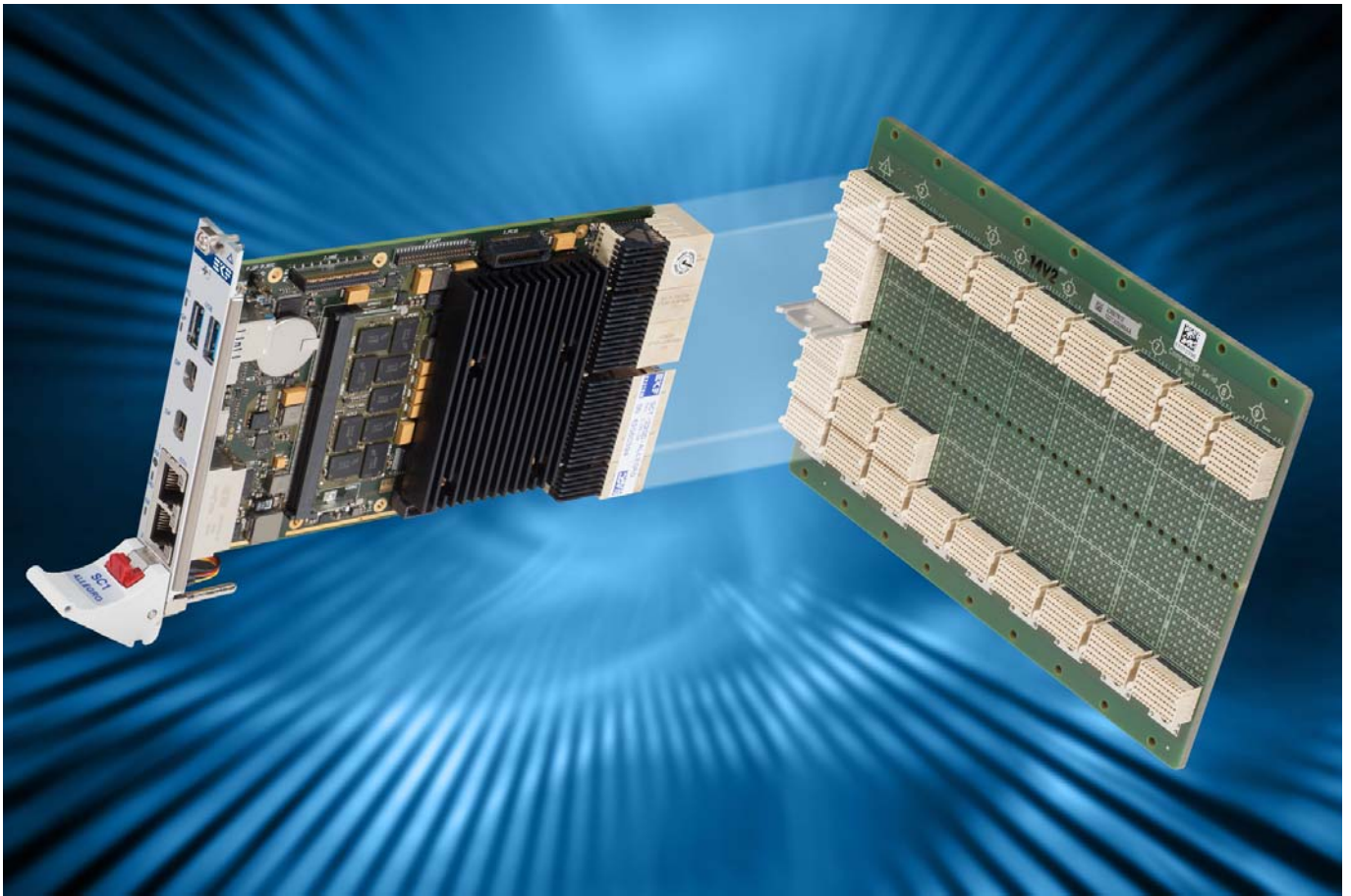

Industrial Computers Made in Germany  
boards. systems. solutions.

EKF Elektronik GmbH  
Philipp-Reis-Str. 4 (Haus 1)  
Lilienthalstr. 2 (Haus 2)  
59065 HAMM  
Germany



Phone +49 (0)2381/6890-0  
Fax +49 (0)2381/6890-90  
Internet [www.ekf.com](http://www.ekf.com)  
E-Mail [sales@ekf.com](mailto:sales@ekf.com)